

# NCAT

# Asphalt Content Furnace

## Service Manual

---

# Table of Contents

Introduction.....	5
What is an NCAT Asphalt Test Furnace? .....	5
Why Test Asphalt? .....	5
Why Improve the Existing Method of Asphalt Testing? .....	5
Barnstead International's Involvement.....	6
How Does the NCAT Work? .....	6
Unpacking and Installation .....	7
Electrical Specifications .....	7
Site Selection.....	9
Power Requirements .....	9
Exhaust Installation Tips .....	9
Installation Drawings .....	11
Balance .....	13
OHAUS vs. SETRA .....	13
SETRA Balance Replacement.....	13
OHAUS Fuse Location .....	14
OHAUS Display Board.....	14
OHAUS and SETRA Ribbon Cables .....	14
Replacement Parts .....	14
OHAUS Balance.....	15
Installation .....	15
Balance Control Port Hole Location .....	17
OHAUS Time and Date Set Procedure .....	18
Resetting the User Variables of an OHAUS Balance .....	20
OHAUS Balance Calibration .....	25
SETRA Balance .....	27
SETRA Balance Installation.....	27
Balance Control Port Hole Location .....	29
SETRA Time and Date Set Procedure .....	30
Resetting Variables of a SETRA Balance to Factory Default.....	32
SETRA Balance Calibration.....	33
Error Conditions .....	35
OHAUS Balance .....	35
SETRA Balance .....	36
Printer .....	37
Thermal Paper Storage .....	37
RS232 Connection Information .....	37
Printer Change (Production) .....	38
Troubleshooting .....	39
Software .....	41
History .....	41
SC859X1 Rev. 1 Software EPROM.....	43
Installation .....	45
Ordering Information .....	47
Procedures .....	48
Amendment .....	48
Definition .....	48

---

## TABLE OF CONTENTS

Output .....	59
Bitumen Ratio .....	59
Glossary .....	60
Errors .....	63
Red Display (Furnace).....	63
Green Display (Balance) .....	66
NCAT Troubleshooting with No Error Codes Displayed .....	68
Aggregates.....	72
Negative Air Pressure .....	72
Displayed Letters/Numbers .....	74
Equipment Test Procedure.....	81
Removal of the Control Assembly (Bottom Section) in the 1087 and 1275 Series NCAT .....	81
1087 Series Back Wall Insulation Removal.....	88
Heating Elements .....	89
Element Part Numbers and Cold Resistance .....	95
Thermocouples .....	98
Solid State Relays .....	101
Keypad.....	104
Maintenance.....	110
Lift Test Procedure .....	110
Cleaning Procedure for NCAT .....	111
Chamber Temperature Verification/Calibration .....	112
Balance Calibration .....	115
Drawings.....	116



---

# Introduction

---

## What is an NCAT Asphalt Test Furnace?

The NCAT Asphalt Content Furnace is a unitized furnace, electronic weighing system, and exhaust air filtration mechanism combined into one system. The system was developed by a team of Barnstead International engineers in conjunction with the National Center for Asphalt Technology (hence the name NCAT) at Auburn University. The NCAT furnace was designed as an improvement over the existing solvent method of determining the binder content in asphalt paving materials.

---

## Why Test Asphalt?

Hot mix asphalt used for roads and highways has to be incredibly durable, withstanding not only the rigors of heavy truck and car traffic, but also the temperature extremes of tropical summers and arctic winters.

---

## Why Improve the Existing Method of Asphalt Testing?

Existing testing methods are extremely time consuming and difficult to perform properly.

---

## Barnstead International's Involvement

Because the NCAT researchers at Auburn University decided that their new test method would use high temperature to separate the asphalt from the aggregate in the asphalt mix, they needed a company that specialized benchtop high temperature laboratory furnaces.

---

## How Does the Asphalt Content Furnace Work?

A known weight of asphalt mix is placed in the NCAT furnace chamber. The furnace then burns away the binder until only the stones remain. The automatic weighing system incorporated into the unit monitors the reduction in weight of the sample as the binder burns off until the weight change stops (meaning all the binder has been burnt away and only stones remain). The software within the unit then calculates the percent of binder within the asphalt mix. All of this is included on a paper printout by a small built-in strip recorder so that the lab technician can confirm that the tested sample of asphalt did meet accepted quality standards. All of this may sound simple, but it isn't. An especially difficult technological problem was how to eliminate the black soot that would normally billow out of the furnace exhaust as the asphalt binder burned away. Our engineers developed a special ceramic filtration/burner system so effective that the outside exhaust is essentially invisible and meets all guidelines for emissions set by the Environmental Protection Agency. This solution was so innovative that the U.S. Patent Department has granted several patent claims to Barnstead International.

---

# Unpacking and Installation

---

## Electrical Specifications

Model #	Voltage	Amperage	Watts	Phase
F85930	240Vac	27 Amps	6379	50/60Hz, Single
F85930	220Vac	20 Amps*	4879	50/60Hz, Single
F85938	208Vac	28 Amps	5757	50/60Hz, Single
F85930-33	240Vac	27 Amps	6379	50/60 Hz, Single

*\*Model # F85930 units are configured for a 27 Amp supply when shipped from the factory. You have the option of re-configuring the wiring at the back of the furnace for 20 amps. Please refer to the owner/operator manual for instructions on how to re-wire the unit for the lower amperage configuration. Typically, a 20-amp configuration is used for mobile laboratory installations where the power supplies may be limited. Units configured for 20 amps will heat and process samples at a slower rate.*

- **NCAT furnaces are not supplied with a power cord or plug** and must be wired either directly through a conduit system or by a customer supplied power cord and plug. Electrical wiring should conform to local electrical code requirements. Please consult with a certified electrician for electrical connection.
- *NCATs sold in the 208V version should **not** be connected to 240V power supply.* Damage to electrical components in the furnace will occur.
- *NCATs sold in the 240V version should **not** be connected to 208V power supply.* Damage to electrical components in the furnace will occur.
- Buck/Boost low voltage isolation transformers are an electrical device that has the ability to step up a 208V power supply to 240V or step down a 240V power supply to 208V. Buck/Boost transformers are available at Barnstead International (P/N TNX122) or can be purchased at local electrical retail stores.
- Recommended buck/boost transformer ratings (TNX122):

MFR:	Jefferson Electric
MFR Model:	216-1241-000
Ratings:	.75 kVA
	Single Phase (50/60Hz)
	120/240 Volts
	16/32 Volts

## UNPACKING AND INSTALLATION



*Barnstead International "packs" a chamber to transport an NCAT from one location to another, preventing damage.*

### Parts Shipped in Chamber:

- (8) JSX122 - Balance/Hearth Plate Ceramic Support Tubes

### Parts Shipped in Accessory Box (Located on top of unit - not pictured)

- PHX4 - Hearth Plate
- (2) FZX47 - Fuses
- (2) FZX53 - Fuses
- (2) FZX61 - Fuses
- ME859X1 - Balance
- LT1275X1 - Manual

**Note**

This manual does not include all information necessary to properly install an NCAT. Please refer to owner/operator manual.

---

## Site Selection

- The NCAT should be mounted on a sturdy level surface, capable of supporting the weight of the fully assembled furnace (Approximately 300 pounds).
- Allow a minimum space of 6 inches between the NCAT outer casing and any vertical surfaces such as the walls of the building for airflow requirements and heat escape. The chamber door must be permitted to swing freely to allow loading and unloading of the chamber.
- Locate the furnace so that you can direct the furnace emissions through ducting to a fume hood or other appropriate ventilation systems. We recommend an exhaust length of not more than 10 feet.

---

## Power Requirements

The NCAT units are not supplied with a power cord due to the large amperage draw. Please consult with a certified electrician to have the NCAT hardwired or an appropriate power cord and receptacle installed in your facility. Electricians will ensure compatibility among furnace specifications, power source and ground code requirements.

---

## Exhaust Installation Tips

- See Installation tips in the Owner/Operator manuals for more information and/or refer to installation drawings for additional information on installation.
- Minimize bends in exhaust tubing as much as possible. (Rule of thumb: Only one 90° bend allowed in exhaust tubing 10 feet in total length.)
- Exhaust exiting the furnace port may reach temperatures as high as 270°C. Keep all flammable material a safe distance from the furnace.
- 3-inch outside diameter, flexible stainless steel tubing works best for exhaust duct-work.

---

## INSTALLATION

Available from Barnstead International, P/N TU859X1.

- Install rock-wall cloth rated to handle temperatures up to 270°C to insulate the exhaust tubing passing through ceiling ducts.
- Do not use exhaust tubing less than 3 inches in diameter.
- Do not use galvanized tin tubing or double wall tin tubing.
- Do not connect the NCAT exhaust port directly to an external fan with a rating of more than 60 CFM. This will create a negative airflow in the exhaust system. The blower motor in the NCAT is rated at 65CFM and will provide enough power for emission up to approximately 10 feet.

### Single Unit Installation Examples

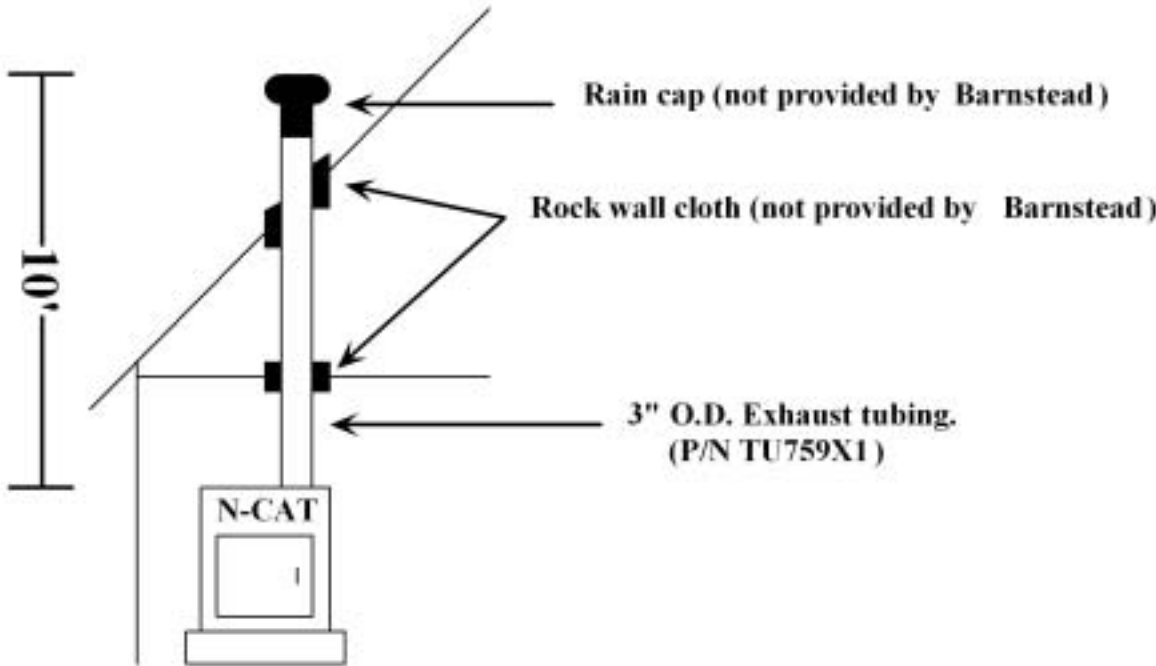

**NOTE:** Please consult a local HVAC technician for local building fire code requirements before installing.

**NOTE:** Barnstead does not supply any materials for installation other than 3" O.D. exhaust tubing (P/N TU759X1) sold as an accessory.

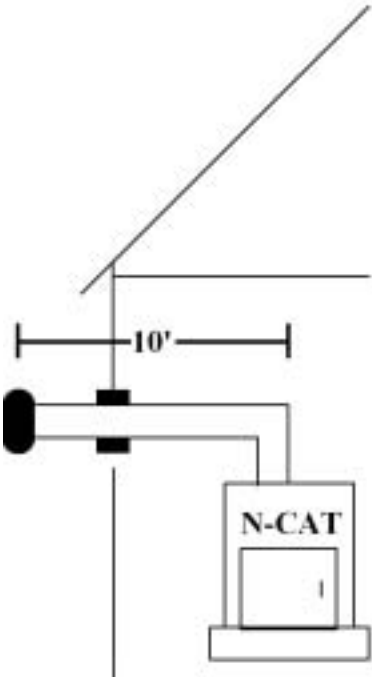

## Multiple Unit Installation Example

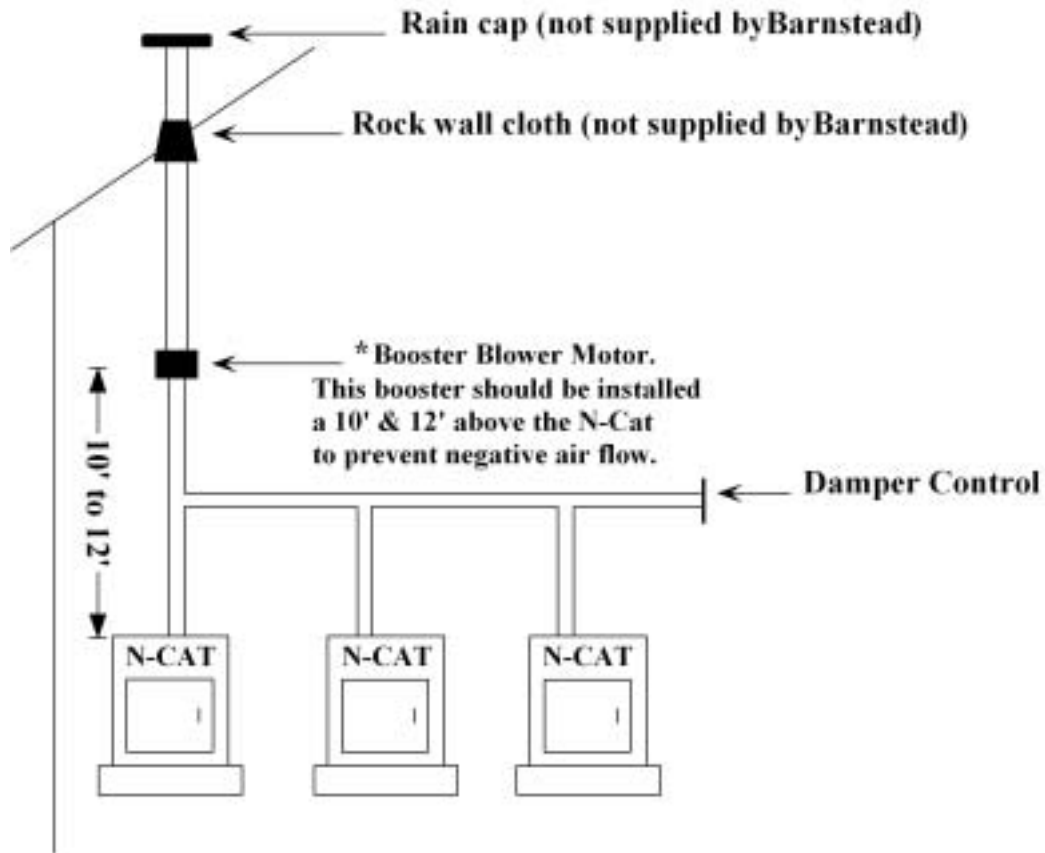

**\*The Booster Blower Motor should have an ON/OFF toggle switch wired next to the N-Cat main control panel. The blower motor should only be activated with the toggle switch when a test is initiated with the N-Cat. Barnstead International does not offer a Booster Blower Motor. To size an additional booster blower more, please consult and HVAC technician.**

**NOTE: Please consult a local HVAC technician for local building fire code requirements before installing.**

**NOTE: Barnstead does not supply any materials for installation other than 3"O.D. exhaust tubing (P/N TU759X1) sold as an accessory.**

# Balance



*OHAUS balance and display board*



*SETRA balance and display board*

The original NCAT (Series 859 & 945) were all manufactured with an OHAUS balance, model GT8000. Design changes still found OHAUS balances being used in the 1087 series until February 1998, in which a manufacturing change from OHAUS to SETRA was completed.

---

## OHAUS vs. SETRA

- The physical appearance between both scales is different, with the housing of the OHAUS balance being brown or tan in color and housing of the SETRA being gray or silver.
- OHAUS balances are a 240 VAC powered scale and the SETRA are a 15 VDC powered scale.
- The display board for the SETRA is mated with a load cell or silver colored base. Whereas the OHAUS load cells and display boards can be interchanged. (A 6 digit number can be found on the SETRA load cell and on the mated display board.)
- The SETRA balance does not contain the numerous user variables found in the OHAUS, making functions, such as resetting the time or date and calibrating the SETRA much easier.
- The SETRA does not require a special calibration plate, as does the OHAUS. (The hearth plate can be left in the chamber, when calibrating the SETRA.)

---

## SETRA Balance Replacement

When replacing SETRA balances, the balance (load cell) and display board **MUST** be changed out as a matched pair. Locate the decal on the back of the balance (load cell) with a 6 digit number. Locate the decal on the display board with the 6-digit number. Ensure the numbers on both parts match. If they do not match, the balance will not function properly. **When customers return SETRA balances, they MUST return the matching display board for warranty coverage.**

---

## BALANCE



---

### OHAUS Fuse Location

The OHAUS balances have a fuse installed on the back of the load cell. The black, rectangular fuse holder/cap is located as part of the power entry module. The cap also has voltage markings on each side. The side facing towards the top of the balance is how the holder/cap should be positioned for the corresponding supply voltage. The fuse is rated at 250V, 160ma. Barnstead International replacement fuse is P/N FZX60. If the fuse opens the red display will indicated ERR 8.

---

### OHAUS Display Board

Part number PCX22 was set up as a replacement part number for display boards for OHAUS balances ONLY. The part is obsolete and can no longer be ordered.

---

### OHAUS and SETRA Ribbon Cables

The ribbon cables that directly attached to the OHAUS and Setra balances are part of the balance and do not have replacement part numbers.

---

## Replacement Parts

Part Number	Description
ME859X1	SETRA upgrade kit. For customers wanting to update their NCAT from the OHAUS to the SETRA balance. This kit includes all the necessary wire harnesses needed to connect a new SETRA balance and installation instructions.
ME1087X1/C	New SETRA balance for warranty situations. (This part number was set up for customers with SETRA balances that fail within warranty.)

---

# OHAUS Balance

---

## Installation

The OHAUS Balance (GT8000) operates on 208Vac or 240Vac (full potential line voltage). The balance is configured for supply voltage that corresponds with the NCAT upon production at Barnstead International.

OHAUS balances were used in production from 1995 to 1998 and are currently sold as replacements only.

1. Ensure that both the balance and the furnace are disconnected from the power supply. Remove the four screws along the top of the front control panel securing the control panel to the lower case of the furnace.
2. Open the lower control panel by carefully swinging the control panel down (hinged).
3. Inside the lower control assembly, observe the suspended table supported by four aluminum rods. The balance will be supported by this table. Vacuum the table if dust, etc., appear on it.
4. Mount the platform support plate on the balance. Note the four pins on the support plate. These will retain the ceramic support tubes, which will project into the furnace chamber after mounting.
5. Orient the balance so that the front of the balance faces the back of the furnace. Run the cable attached to the front of the balance under the balance, so that the unattached end of the cable emerges from beneath the back of the balance.
6. Slide the balance front-first onto the suspended table beneath the furnace chamber.
7. Position the balance so that the pins on the platform support plate are directly beneath the four tube ports in the bottom of the furnace chamber.
8. Plug the balance's power cord (the black, three-pronged female plug) into the socket on the rear

of the balance. Plug the nine-pin ribbon cable female socket from the controller into the corresponding socket on the back of the balance. Plug the 13 pin socket on the display cable (the cable from the front of the balance running beneath the balance) into the 13 pin connector located on the lower right-hand edge (as you face the unit) of the balance display board (mounted on the right-hand side of the front control panel).

9. Open the furnace door. Mount the four ceramic support tubes through the tube ports located in the bottom of the furnace chamber. Adjust the position of the balance until the four ceramic support tubes are seated on the appropriate pins on the balance plate. Finely adjust the position of the balance until the tubes are centered in their ports, but not touching the sides of the ports,
10. Mount the hearth tray on the four ceramic support tubes. Place the smooth side of the hearth tray down, with the ridges on the top of the hearth tray running from the front to the back of the furnace chamber.
11. Close the lower case by returning the control panel to its original position. Secure the control panel with the four screws you removed in step 1.

## Balance Control Port Hole Location

There are 4 holes strategically placed on the front of the control panel, between the green display and the red displays. These holes are used to access and adjust the balance variables. Use an appropriate sized tool or paper clip to access balance keys through the port holes in the control panel. Reference the sketch of the control panel for location/identification of balance control port holes which will need to be accessed to perform balance time/date setting, balance resetting, and balance calibration procedures.

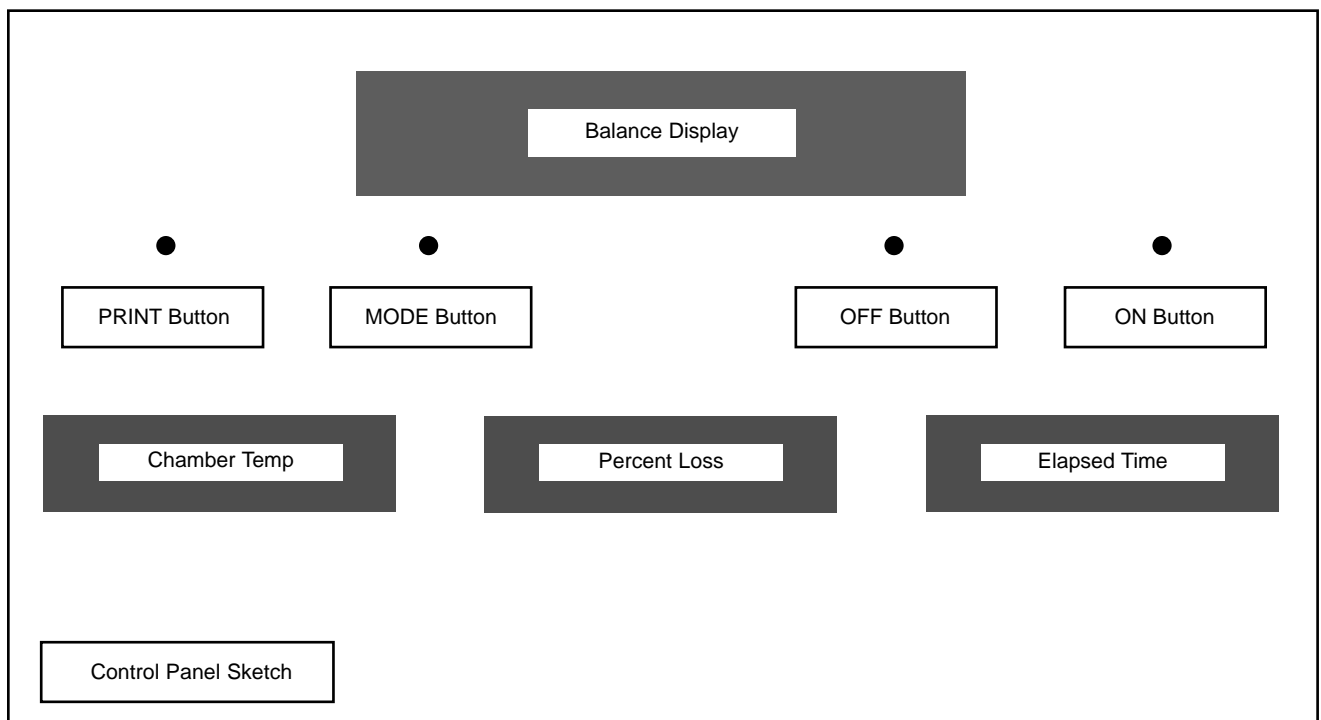

## OHAUS Time and Date Set Procedure

The balance supplies the time & date to the microprocessor of the NCAT. For ease of record keeping and to allow the microprocessor to function properly, please ensure the time and date are set appropriately.

The balance is shipped with the time & date set to Central Daylight Time or Central Standard Time, depending on the time of the year the balance is purchased. If you wish to adjust these settings for local time, please follow the outlined procedure.

*Note: The OHAUS balance must be set up for US date settings and EURO time (24 hour format) settings or it will not communicate with microprocessor in the NCAT correctly.*

1. Power down the NCAT furnace using the green power switch. Press and hold the number "4" key on the keypad. While holding down the "4" key, power up the NCAT using the green power switch. Hold the "4" key until you hear the NCAT beep. Release the "4" key.
2. Press and hold the balance ON button. Release when "Menu" appears on the balance display.
3. "Menu" will automatically change to "Cal". When "Cal" is displayed, repeatedly press the MODE button until "Setup" is displayed.
4. Press the ON button. "Reset" will be displayed.
5. Repeatedly press the MODE button until "Time" is displayed.
6. Press the ON button. "Type" will be displayed.
7. Press the ON button. "US" will be displayed.
8. Press the MODE button. "Euro" will be displayed.
9. Press the ON button. "Type" will be displayed again.

10. Press the MODE button. "Set" will be displayed.
11. Press the ON button. The display will indicate time with the first two digits (hours) flashing.
12. Repeatedly press (or press and hold to scroll) the MODE button until the current hour (24 hour clock) is displayed.
13. Press the ON button. The last two digits (minutes) will flash.
14. Repeatedly press (or press and hold to scroll) the MODE button until the current minute is displayed.
15. Press the ON button. "Set" is displayed.
16. Press the MODE button. "End, Time" will be displayed.
17. Press the ON button. "Time" will be displayed again.
18. Press the MODE button. "Date" will be displayed.
19. Press the ON button. "Type" will be displayed.
20. Press the ON button. "US" will be displayed.
21. Press the ON button. "Type" will be displayed again.
22. Press the MODE button. "Set" will be displayed.
23. Press the ON button. The display will not indicate the date with the first two digits (month) flashing.
24. Repeatedly press (or press and hold to scroll) the MODE button until the current month is displayed.
25. Press the ON button. The second two digits (date) will flash.

26. Repeatedly press (or press and hold to scroll) the MODE button until the current date is displayed.
27. Press the ON button. The last two digits (year) will flash.
28. Repeatedly press (or press and hold to scroll) the MODE button until the current year is displayed.
29. Press the ON button. "Set" will be displayed.
30. Press the MODE button. "End, Date" will be displayed.
31. Press the ON button. "Date" will be displayed.
32. Repeatedly press the MODE button until "End, Setup" is displayed.
33. Press the ON button. "Setup" will be displayed.
34. Press the MODE button until "End, Menu" is displayed.
35. Press the ON button. The display will revert to displaying the current sample weight.
36. Power down the NCAT and power back up using the green power switch to exit the balance adjustment mode.

---

## Resetting the User Variables of an OHAUS Balance

In the event that your furnace ceases to operate and displays error code E008, check that the balance is properly connected to furnace as described in Balance Installation. If the balance is properly connected but the furnace is still failing to operate and is still displaying E008, you need to reset the balance's parameters. (Reference the sketch, depicting the balance control port holes.)

---

## To reset balance

1. Power down the NCAT furnace using the green power switch. Press and the hold the number “4” key on the keypad. While holding down the “4” key, power up the NCAT using the green power switch. Hold the “4” key until you hear the NCAT beep. Release the “4” key.
2. Press and hold the ON button. Release when “Menu” appears on the balance display. “Menu” will automatically change to “Cal”.
3. Press the MODE button. “User” will be displayed.
4. Press the ON button. “Reset” will be displayed.
5. Press the ON button. “Yes” will be displayed.
6. Press the ON button to reset the user menu to the OHAUS default values. You will know this when this has been done when you hear a short train of beeps.
7. Press the MODE button. “AL” (Averaging Level) will be displayed. Select this by pressing ON. This will display “AL-1”. The correct value is AL3. In order to change the averaging level, continue pressing MODE until AL3 is displayed. Press the ON to accept the new value. The menu option “AL” will be displayed again.
8. Press and release the MODE button until the menu option “Auto-O” is displayed. Press the ON button to select. Repeatedly press the MODE button until “Off” is displayed. Press the ON button to accept this option.
9. Press and release the MODE button until the menu option “End User” is displayed. Press the ON button to select. This will take you back to the User Menu.
10. Press the MODE button. “Setup” will be displayed. Press the ON button to accept the choice. Display will read, “Reset”.

11. Press the ON button. "Yes" will be displayed. Pressing the ON button again will reset the Setup menu to the OHAUS defaults. You will know when this has been done when you hear a short train of beeps.
12. Repeatedly press the MODE button until the "Time" menu option is displayed.
13. Press the ON button to select. "Type" will be displayed.
14. Press the ON button. "US" will be displayed.
15. Press the MODE button. "EURO" will be displayed.
16. Press the ON button to select "EURO" (Military time).
17. Repeatedly press the MODE button until the word "Set" is displayed.
18. Pressing the ON button will display the time that is entered into the balance. If the time is incorrect, it may be changed by pressing the MODE button to cycle through the hours. Once the correct hour is displayed, press the ON button to accept the new hour setting and move to the minutes setting. Press the MODE button to cycle through the minutes. Once the correct minutes are displayed, press the ON button to accept the new minute setting at which time the display will change to read "Set".
19. Press the MODE button. "End" is displayed.
20. Press the ON button. "Time" is displayed.
21. Press the MODE button. "Date" will be displayed.
22. Press the ON button to select. "Type" will be displayed.
23. Press the MODE button. "Set" will be displayed. This menu will allow the date to be changed if

incorrect. Pressing the ON button will display the date. The date may be changed by pressing the MODE button to first change the month, day and year respectively, as was done with changing the time. After pressing the ON button when selecting the date, the menu option "Set" is displayed.

24. Press the MODE button. "End" is displayed.
25. Press the ON button to select. "Date" is displayed.
26. Repeatedly press the MODE button until "End" is displayed.
27. Press the ON button to select. This will take you back to the setup mode.
28. Press the MODE button. "Print" will be displayed.
29. Press the ON button to select. "Reset" will be displayed.
30. Press the ON button. "Yes" will be displayed.
31. Press the ON button again will reset the Print menu to OHAUS default values. You will know when this has been done when you hear a short train of beeps.
32. Press the MODE button. "Com" will be displayed. (Communication parameters of the balance).
33. Press the ON button. "Baud" will be displayed.
34. Press the ON button. "Baud Rate" will be displayed.
35. Repeatedly press the MODE button until "BR9600" appears. When it does, press the ON button to approve the selection. "Baud" will be displayed.

36. Press the MODE button until "Data" is displayed. Press the ON button to display the current parameter setting. Change setting to read "8 Data" by pressing the MODE button. Press the ON button to approve the setting, which will display "Data".
37. Press the MODE button until "Stop" is displayed. Press the ON button to display the current parameter. Change setting to read "1 Stop" by pressing the MODE button. Press the ON button to approve the setting, which will display "Stop".
38. Press the MODE button until the word "End" is displayed. Press the ON button. "Com" will be displayed.
39. Press the MODE button until the word "Options" is displayed. Press the ON button to enter the menu. "Auto" will be displayed. Repeatedly press the MODE button until the word "Time" is displayed. Press the ON button to enter this menu. Change setting to "On" by pressing the MODE button. Press the ON button to approve the setting. "Time" will be displayed.
40. Press the MODE button until the word "Date" is displayed. Press the ON button to enter the menu. Change the printing of the date to "On" by pressing the MODE button. Press the ON button to approve the selection. "Date" will be displayed.
41. Press the MODE button until the word "End" is displayed. Press the ON button until the word "Options" is displayed. Repeatedly press the MODE button until the word "End" appears. Press the ON button until the word "Print" is displayed.
42. Press the MODE button until the word "End" is displayed. Press the ON button to approve this selection. The balance will display weight again, and is no ready to be used with the NCAT furnace.

43. Power down the NCAT with the green power switch and power back on again to exit balance adjustment mode.

---

## OHAUS Balance Calibration

OHAUS balance calibration should be performed to ensure accurate weighing. Calibration is performed with the calibration plate (provided by B/I) and a set of certified weights (8000 grams).

You need to have the calibration plate and certified N.I.S.T. weights to perform the calibration.

NOTE: Span calibration works best at 4000 grams given the application with the NCAT.

The OHAUS balance also has linearity and user calibration modes. However, due to the nature of the application, calibration of the balance in either of these two modes is not necessary.

1. Power down the NCAT, allowing the unit to cool to ambient chamber temperature.
2. Open the furnace door and remove the hearth plate (setting on top of the four ceramic support posts. (Door remains open until calibration is complete.)
3. Place the calibration plate (P/N = PT859X7) on top of the four ceramic support posts, ensuring the plate is centered.
4. Press and hold the #4 key on the keypad in. While the #4 key is held, turn the green power switch on as to power up the NCAT. When the unit beeps, you may release the #4 key.
5. Access the balance control buttons through the pin holes located on the front of the control panel (Reference the sketch depicting the balance control port holes.)
6. Press the ON button. "Menu" is displayed followed automatically by "Cal".

7. Press the ON button again. "Span" is displayed followed by "C 0g".
8. Press the ON button again to start the Span calibration. "-C-" is displayed followed by the value of mass which must be placed on the platform such as "C 2000g". NOTE: DO NOT DISTURB THE BALANCE WHEN "-C-" IS DISPLAYED.
9. Repeatedly press the MODE button to select the percentage of the mass on the display. (25% = 2000g, 50% = 4000g, 75% = 6000g, 100% = 8000g.)
10. Place the required mass on the calibration plate.
11. Press the ON button. "-C-" displayed while the balance calibrates. NOTE: DO NOT DISTURB THE BALANCE WHEN "-C-" IS DISPLAYED.
12. Display will automatically indicate "S" followed by the calibration weight when calibration is complete.
13. Remove the mass from the calibration platform. "S 0.00g" is displayed indicating the balance is now in weighing mode and the SPAN calibration is complete.
14. Power down the NCAT unit.
15. Remove the calibration platform and reinstall the hearth plate, ensuring it is centered on the four ceramic support posts.
16. Calibration complete.

---

# SETRA Balance

---

## SETRA Balance Installation

\*Steps 1-5 also refer to replacing an existing balance.

1. Lower the front control panel by removing the screws. Locate the balance display board mounted on the back of the front control panel. This is the board that illuminates with green numbers when the unit is powered up.
2. Remove this board from the unit.
3. Mount the new P.C board that comes with the balance in this position.
4. Open the chamber-door and remove the load plate. Remove the (4) ceramic support collars that extend downward into the control section of the furnace.
5. Remove the old balance from the control section of the furnace. (Disconnect wire harnesses.)
6. Secure the support plate with (4) screws on SETRA balance.
7. Set the SETRA balance (load cell) in the control section of the furnace.
8. Connect the 10-pin gray ribbon cable that protrudes from the bottom of the silver SETRA balance into P2 on the new display board.
9. Connect the 9-pin gray ribbon cable to P3 on the new display board. Connect the other end of the 9-pin gray ribbon to J5 on the main control board (PC859X1A) mounted in the NCAT control section.
10. Connect the 15Vdc power cable (red and white wires) to P6 on the new display board. Connect the white wire on the opposite end of the cable to J29 on the main control board mounted in the NCAT control section. Connect the red wire to J30 on the main control board mounted in the NCAT control section.

---

## SETRA BALANCE

11. Install the 4 ceramic support posts down through the holes in the chamber so they straddle the support plate of the balance. Physically maneuver the balance (load cell) in such a manner to ensure each of the 4 ceramic support posts are not in contact with any part of the NCAT chamber section.
12. Set the load plate back on the (4) ceramic support posts in the chamber. Make sure the load plate does not come in contact with the sides of the chamber.
13. Raise the control panel and secure with 4 screws.

Installation of the new SETRA balance is complete. The “time and date” will have to be properly set and the balance should be calibrated before usage.

## Balance Control Port Hole Location

There are 4 holes strategically placed on the front of the control panel, between the green display and the red displays. These holes are used to access and adjust the balance variables. Use an appropriate sized tool or paper clip to access balance keys through the port holes in the control panel. Reference the sketch of the control panel for location/identification of balance control port holes which will need to be accessed to perform balance time/date setting, balance resetting, and balance calibration procedures.

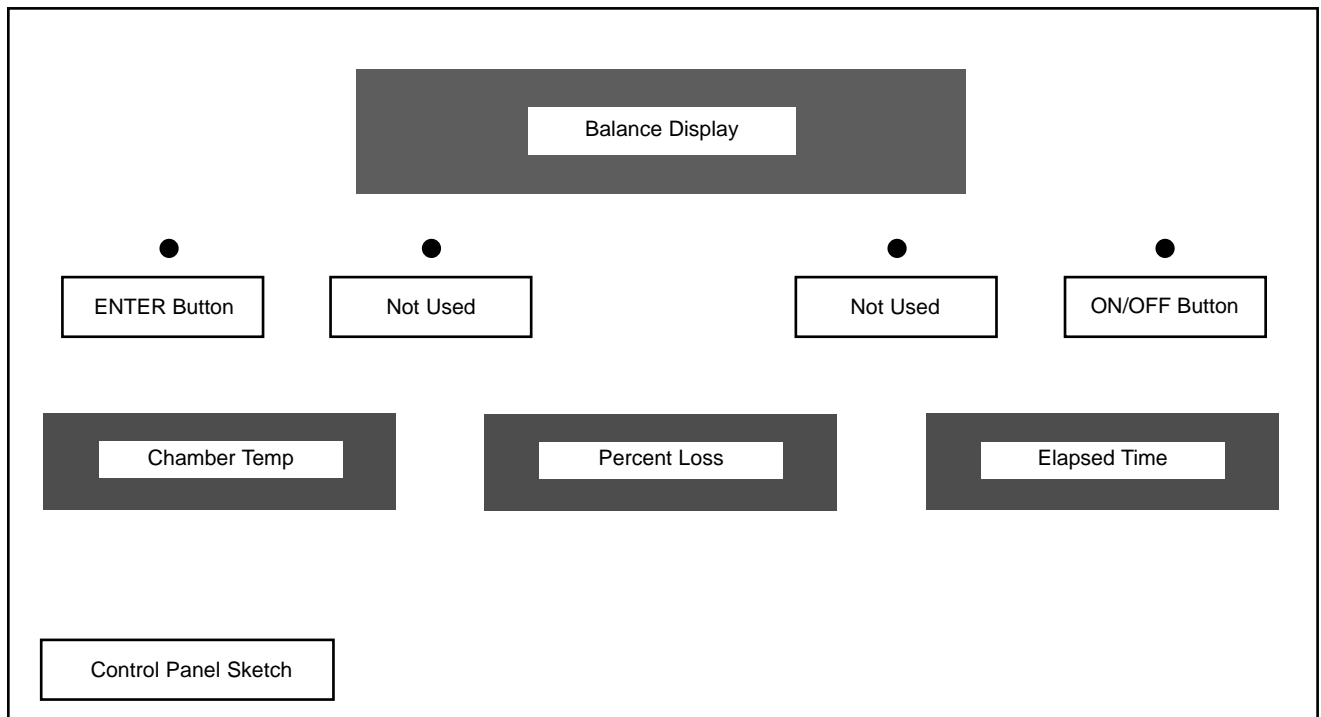

---

## Setra Time and Date Set Procedure

The balance supplies the time & date to the microprocessor of the NCAT. For ease of record keeping and to allow the microprocessor to function properly, please ensure the time and date are set appropriately.

The balance is shipped with the time & date set to Central Daylight Time or Central Standard Time, depending on the time of the year the balance is purchased. If you wish to adjust these settings for local time, please follow the outlined procedure.

Note: The Setra balance must be set up for US date settings (2-tear) and a 24 hour clock format or it will not communicate with the microprocessor in the NCAT correctly.

---

### To Set the Time

1. Turn the green power switch on the furnace control panel to the OFF position.
2. Press & hold the # 4 key while turning the green power switch to the ON position. (Hidden Key 4 procedure). The red display will indicate [BAL CAL]. Release the # 4 key when the NCAT beeps once.
3. Press and hold the balance ON/OFF key with a small device such as straightened paper clip. (Note balance control port holes in control panel sketch.)
4. Press the balance ENTER key with a second small device such as a straightened paper clip. (Note balance control port holes in control panel sketch.)
5. Release both keys simultaneously. [71nE] will be displayed.
6. Press the balance ENTER key. The two-hour digits will be blinking in 24-hour format.
7. Press the balance ON/OFF key until the correct hour is displayed. Press ENTER.

8. Press the balance ON/OFF key until the correct minute is displayed. Press ENTER.
9. Press the balance ENTER key, the balance will return to the normal weight display.

---

### To Set the Date

1. Power down the NCAT. (Green Power Switch).
2. Press & hold the # 4 key while powering the NCAT back up. (Hidden Key 4 procedure). The red display will indicate [BAL CAL]. Release the # 4 key when the NCAT beeps once.
3. Press & hold the balance ON/OFF key with a small device such as straightened paper clip. (Note balance control port holes in control panel sketch.).
4. Press & hold the balance ENTER key with a small device such as straightened paper clip. (Note balance control port holes in control panel sketch.).
5. Release both keys simultaneously. [71nE] will be displayed.
6. Press the balance ON/OFF key. [dA7E] will be displayed.
7. Press the balance ENTER key. [US] or [Eur0] date type will be displayed.
8. Press the balance ON/OFF key until [US] is displayed.
9. Press the balance ENTER key [2d Yr] or [4d Yr] will be displayed.
10. Press the balance ON/OFF key until [2d Yr] is displayed.
11. Press the balance ENTER key. [dAY xx] will be displayed.

12. Press the balance ON/OFF key until the desired day is displayed.
13. Press the balance ENTER key. [nn xx] will be displayed.
14. Press the balance ON/OFF key until the desired month is displayed.
15. Press the balance ENTER key. [Yr xx] will be displayed.
16. Press the balance ON/OFF key until the desired year is displayed.
17. Press the balance ENTER key. The display will revert back to normal weight indication screen.

---

## Resetting Variables of a Setra Balance to Factory Default

This function is to reset the parameters inside the balance, which are not user accessible. The TIME, DATE, and CALIBRATION are not affected.)

1. Turn the green power switch on the furnace control panel to the OFF position.
2. Press & hold the # 4 key while turning the green power switch to the ON position. (Hidden Key 4 procedure). The red display will indicate [BAL CAL]. Release the # 4 key when the NCAT beeps once.
3. Press & hold the balance ON/OFF key with a small device such as straightened paper clip. (Note balance control port holes in control panel sketch.).
4. Press & hold the balance ENTER key with a small device such as straightened paper clip. (Note balance control port holes in control panel sketch.).

5. Release both keys simultaneously. [71nE] will be displayed.
6. Press the balance ON/OFF key three consecutive times. [FACdEF] will be displayed.
7. Press the balance ENTER key. [BUSY] will be displayed.
8. The balance display will automatically revert back to normal weight indication screen when reset is complete.

---

## Setra Balance Calibration

1. Turn power to the NCAT unit OFF.
2. Open chamber door and allow unit (Chamber) to cool to ambient temperature. NOTE: DO NOT attempt calibration with warm/hot chamber. The chamber door will remain open during the entire calibration procedure and the chamber must be at ambient temperature.
3. Make certain the chamber ceramic hearth plate is centered on supports posts and free of debris.
4. Press & hold the # 4 key while powering the NCAT back up. (Hidden Key 4 procedure). The red display will indicate [BAL CAL]. Release the # 4 key when the NCAT beeps once.
5. Press & hold the balance ON/OFF key with a small device such as straightened paper clip. (Note balance control port holes in control panel sketch.).
6. Press & hold the balance ENTER key with a small device such as straightened paper clip. (Note balance control port holes in control panel sketch.).
7. Release both keys simultaneously. [71nE] will be displayed.

---

## SETRA BALANCE

8. Press the balance ON/OFF key two consecutive times. [CAL] will be displayed.
9. Press the balance ENTER key. [LOAD 8000] will be blinking on display.
10. Place 8000 grams of certified weight (NIST traceable) on the ceramic hearth plate. [0.0] will be displayed. NOTE: DO NOT proceed to step 11 until display reads [0.0].
11. Press the balance ENTER key. [BUSY] will be displayed.
12. The balance display will automatically revert back to normal weight indication screen when calibration is complete. The software of balance calculates its own offset when the display is reading [BUSY].

---

# Error Conditions

---

## OHAUS Balance

(Not a complete listing of error codes, but most common.)

<b>Error Displayed</b>	<b>Problem</b>	<b>Solution</b>
3.0	Calibration Error – Incorrect or no calibration weight used for calibration.	Recalibrate with correct weights. Make sure all debris is off the top of the balance and the posts supporting the aluminum calibration plate are centered. Only the aluminum calibration plate should be used during the calibration procedure. If this error is only displayed when calibrating the unit, the software is bad and the unit needs to be replaced.
4.4	RS232 buffer is full. There is a bad connection in balance.	Double check all connections.
8.0	Hardware error causing an internal weight signal, which is too low.	Check if the platform or platform support is off. If not, balance must be serviced.
EEEE	Displayed momentarily – NCAT is getting power disconnect for a brief second and resetting itself.	Check power source. Lower control panel and check all wiring connections - especially to balance.

---

## ERROR CONDITIONS

---

### SETRA Balance

(Not a complete listing of error codes, but most common.)

<b>Error Displayed</b>	<b>Problem</b>	<b>Solution</b>
HHHHH	Exceeds maximum specified load (5000 grams).	Reduce load to specified range.
LLLLL	Load does not meet minimum specified load requirements.	Increase load to specified range. Make sure the ceramic posts are centered and the plate is on top of them.
NOCAL	Unable to do span calibration (load not within 1% of cal weight, or weight unstable.)	Replace scale.
PPPPPP	Strain on the DC power supply.	Disconnect printer to see if the error goes away. If it does, replace printer.
ProtEc	Calibration protect switch not in the PROTECT position during operation.	Check all connections. Replace scale.
REPlug	System not calibrated.	Recalibrate unit.
OFLO	Internal arithmetic overflow.	Replace scale.
S Err	Processor stack overflow.	Replace scale.
In Err	Memory indexing error.	Replace scale.
UnABLE	Unable to process command (usually due to being in improper mode.)	Replace scale.

# Printer



Seiko printer P/N AYX3  
(859, 945, 1087 Series units ONLY)

The printer is a parallel output port for the microprocessor, with the three red digital displays. The microprocessor can be programmed to print the Header and Footer of a test burn (paper saver mode) or the Header, Minute-by-Minute burn information, and finally the Footer. A hidden key one routine will toggle between the two modes of operation.

With the 1275 Series NCATS, Barnstead began manufacturing NCATS with a thermal printer manufactured by Martel. 859, 945, and 1087 with Seiko thermal printers will not function with a Martel printer.



Martel Printer P/N AYX28  
(1275 Series units ONLY)

## Thermal Paper Storage

To store burn tickets, Barnstead International recommends making a copy of the thermal paper ticket on an 8.5 x 11 piece of white paper. Do not store the thermal paper ticket itself as it will discolor and become illegible in time.

## RS232 Connection Information

The 1087 and 1275 series NCATS are equipped with an RS232 port on the back of the control assembly. This enables the NCAT to be connected to an external printer or computer terminal for recording burn information. Contact Atser Inc. at 281-999-9961 to inquire about "Burn-It" software package. B/I does not sell the software or the harness needed to connect the 25 pin female RS232 port (back of NCAT) to a computer.

### Specifications of RS232:

- 8 bits
- 1 stop bit
- No parity
- Stream of data every second
- Computer configuration - Comm port set at 8N1 – continuous
- Hardwire handshake – 9600 Baud



RS232 Port

## PRINTER

### Printer Change (Production)

*Seiko to Martel (1087 to 1275)*

The Seiko printer used in production of the 859, 945 and 1087 series NCAT is obsolete. The new printer is manufactured by Martel and will be used in production starting with the 1275 series NCAT in Oct/Nov of 2001. The software is being changed. The reason for the software update is the degree symbol on the front display would not print with the Martel.

SOFTWARE UPDATE: REV H software was only used in production for a couple of months. Behind the scene changes were made and we are now using Rev I in production.

Part Number	Description
AYX3	Thermal Printer (Seiko)
AYX28	Thermal Printer (Martel)
DL1087X8	Keypad RPO for Seiko printers
DL1275X4	Keypad RPO for Martel Printers



*DL1087X8 keypad -  
1087 series only  
(Seiko printer)*



*DL1275X4 keypad -  
1275 series only  
(Martel printer)*



*DL859X11A keypad -  
859 and 945 series only  
(Seiko printer)*

## Troubleshooting

Problem	Cause	Solution
Printer not printing.	The red LED will not illuminate if paper is removed from the printer. The unit uses thermal paper, which means characters will only show if the paper roll is installed properly.	Remove the paper roll from the printer, turn the paper roll over and reinstall in the printer. Perform a hidden key routine ENTER or WEIGHT key. (Found in operation manual section of this book). The printer is activated to print the user and balance variables immediately. If the unit prints the variables, the printer itself is most likely not defective and the paper roll is installed properly.
	Not printing burn results, but will print user variables when a hidden key is performed. The 859 and 945 Series units are equipped with a printer software on/off key located below the green power switch on the front control panel. If this switch (SWX108) is in the "Off" position or defective, the printer will not print during a burn, yet print user variable information during a hidden key routine.	Check electrical connections on backside of switch on older models. In the 1087 and 1275 series units this switch is removed in place of a jumper wire. Wire harness part number WH1087X2 connects to the A/D Converter PC Board(PC859X3A) on the J1 terminal. Check for continuity or replace this wire harness, as the jumper wire is located on the terminal connector. If the unit still does not print after verifying WH1087X2 is good or replaced, the A/D Converter PC Board may need to be replaced.
	If the printer does not print any information during a burn or when a hidden key ENTER or WEIGHT is performed, yet the displays of the NCAT indicate the unit is functioning properly, then the printer is defective or the wire harness ribbon connecting the printer to the Main Logic PC Board (PC859X1A) is defective. (The wire harness ribbon part number is dependent on the series of NCAT.)	Replace wire harness and/or printer.

## PRINTER

<b>Problem (cont.)</b>	<b>Cause (cont.)</b>	<b>Solution (cont.)</b>
Print coming out upside down, reading right to left.	The Seiko printers are equipped with an internal switch located in the upper left corner of the printer with the cover removed. The small switch can be slid from the left to the right or vice versa.	Power off the NCAT, remove the printer cover, and slide the switch to the opposite position. Replace the cover and perform a hidden key two routine when powering back on. Test printer again. If still printing upside down or right to left, replace the printer.
Printer ticket indicating invalid numbers for weight loss, % loss, calibrated asphalt content, temp comp, and bitumen ratio.	If the time and date are not set properly in the balance, the software in the NCAT automatically moves the decimal place to the left on a burn ticket.	The time and date of the balance (SETRA or OHAUS) needs to be reset. This is not a malfunction of the printer. (An example burn be seen in the Error Code section of this manual.)



*Seiko printer switch*

# Software

## History

The following software revisions were used in the NCAT furnaces. All software versions are interchangeable and if in doubt it is always best to update. The software chip is located on the Main Logic PC Board (PC859X1) next to the balance. A sticker on the chip will indicate the revision letter. Hidden Enter Key routine will also prompt the printer to print the installed revision letter.

Series	Version	Dates Used
859	A – D	Used up to 1995
945	D – E	Used in 1996
1087	F – G	Used in 1997 to 2002
1275	H	Used in 2002 (few months)
1275	I	Used in production currently

Main Logic Board - Software I.C.



Because the software IC chip is a plug-in style chip (no soldering necessary to replace) and interchangeable between every model/series, production dates (beginning and end) are not important.

\*When ordering new software, use part number AY1087X3. The latest version in production will be shipped. Barnstead will not provide software versions used in the past. Only the latest revision is production.

Versions A and B were Beta site versions.

Versions C and D were the first two revisions of beta site software to be used in production. Operation of an NCAT was no different between the software revisions. Changes were all “behind-the-scene” programming to allow the microprocessor to execute commands faster.

Version E: A feature was added to allow operators to program a positive calibration factor.

Version F: Several new operating features were added. They include:

1. Auto program switching to idle mode. (Unit will stop test automatically when the sample is stable and revert to idle mode, placing an asterisk next to endpoint. This feature frees up operator’s time and increases the number of tests that can be run in a days time.)

2. Maximum test time was extended to 255 minutes.
3. Maximum load size increased to 4000 grams.
4. Asphalt content expressed in percent loss on burn ticket.
5. Bitumen Ratio calculated and added to print out test results.

Version G: Several new operating features were added. They include:

1. Programmable time/date function. (This allows operators to program the NCAT to begin heating up automatically at a specific time/date. Operators can arrive to work in the morning to find the NCAT unit all ready up to burn temperature!) If no date is entered, software will revert to a 24 hour time format. The unit must be in the inactivity mode of operation in order for programmable timer to function properly.
2. Inactivity mode. (If no keys are pressed in 4 hours of operation, the display will read "In Ac" in the chamber temp window. This feature will benefit operators with NCATs in remote locations should the operator not be able to return to power off unit in times of non-use.) The unit must be in the inactivity mode of operation in order for programmable timer to function properly.
3. Test interrupt/Power interrupt. (If power to the NCAT is interrupted during a burn and then restored, the furnace will continue the test, preventing smoke buildup in the lab. The burn ticket will print "Results Invalid" with "Test Interrupted".
4. Auto-Shutdown Mode. Software can be toggled by performing a hidden temperature key routine to toggle between Auto and Manual mode of operation. In Auto mode, the unit will recognize the endpoint of a test, stop the blower motor and print the results. The unit will beep once every minute to alert operator the test is complete. In Manual mode, the unit will recognize

the endpoint of a test, place an asterisk next to the endpoint, but continue to run the test, beeping once every 10 seconds to alert the operator the test is complete. Operator must press the START/STOP key to end test.

5. Stability threshold factor expressed in a percentage (0.01% - 0.5%)

Version H: Revision H does not contain any operational differences from Revision G. With revision H, “behind-the-scene” programming changes were made to accommodate the new style of printer being used in production of the new 1275 series units. The only difference operators will see is on sample tickets where the symbol for degrees has been removed from the ticket. Version H was only used in production for a few months in early 2002.

Version I: Revision I is currently being used in production (August 15, 2002) and shipped as replacement software for NCAT units. Revision I contains “behind-the-scenes” changes enabling the software to execute commands faster than version H.

---

## SC859X1 Rev. I Software EPROM

### **Power Interrupt**

If power is lost, then regained during a test, the unit will restart the blower and continue the test until the endpoint is reached. However, it will read “Results Invalid” “Test Interrupted.”

### **Programmable Timer**

New timer allows user to program a specific date and time for the unit to begin its preheat cycle.

### **Inactivity Mode**

Allows user to choose “inactivity mode” which puts unit back to “sleep” as long as no other keys are pressed after 4 hrs. from initial timer wake-up. This mode can be toggled OFF and ON by using the hidden key “Timer” routine. The displayed mode is the active mode.

**Auto Program switching to idle at test endpoint**

- Increases the number tests run per day
- Frees operator's time
- Asterisk documents endpoint on printout (see enclosed sample printout on page 45)

**Maximum test time extended to 255 minutes and load size to 4,000 grams**

- Meets ASTM and AASHTO maximum load size requirements
- Saves time - no need to split sample size

**Asphalt content expressed in percent loss**

- Meets ASTM and AASHTO test result requirements
- Saves time - no need to manually adjust results from gram loss to percent loss

**Bitumen Ratio added to print out test results**

- Meets international and U.S. requirements
- Saves time - no need to perform manual calculations

```

-----
Elapsed Time: 39:00
Sample Weight: 1270g
Weight Loss: 79.8g
Percent Loss: 6.28%
Temp Comp: 0.17%
Calib. Factor: 0.26%
Bitumen Ratio: 6.27%
-----

```

Calibrated Asphalt Cnt  
5.85%

```

-----
39 495 79.8 6.28*
38 494 79.8 6.28
37 495 79.7 6.27
36 495 79.5 6.25
35 497 79.3 6.24
34 499 79.1 6.22
33 503 78.7 6.19
32 506 78.2 6.15
31 509 77.7 6.11
30 513 77.1 6.07
29 516 76.2 6.00
28 519 75.4 5.93
27 521 74.5 5.86
26 524 73.5 5.78
25 526 72.2 5.68
24 528 70.8 5.57
23 529 69.5 5.47
22 530 68.0 5.35
21 531 66.4 5.22
20 531 64.8 5.10
19 532 63.2 4.97
18 536 59.6 4.69
17 536 59.3 4.66
16 536 59.0 4.64
15 537 58.2 4.58
14 539 56.9 4.48
13 546 54.8 4.31
12 563 50.9 4.00
11 612 43.9 3.45
10 640 34.1 2.68
9 536 22.1 1.74
8 459 11.7 0.92
7 439 5.3 0.41
6 433 4.0 0.31
5 427 2.8 0.22
4 420 2.0 0.15
3 414 1.4 0.11
2 409 0.9 0.07
1 411 0.5 0.03
-----

```

```

-----
T:TEMP:WT.LOSS:%LOSS
Filter Set Pt: 750°C
Chamber Set Pt: 500°C
Tested By: LEE NELSON
Mix Type: FM-2
Sample ID: HMA505.1
Time: 15:41:31
Date: 3-11-97
-----

```

Sample printout

## Installation

1. Open hinged front control panel by removing four screws.
2. The SC859X1 EPROM is mounted in a 16-pin socket on the edge of the PC859X1A board on the right side of the furnace. A label on top of EPROM indicates the part number and revision level.
3. Note orientation of the EPROM notched end to rear of the furnace. Gently pry the chip from its socket until removed. Do not use magnetic tools in the vicinity of the EPROM.
4. Gently mount the new EPROM into the open socket. Adjust pins on a flat surface if not matching socket.
5. Refasten control panel.
6. Turn power switch on. Review and adjust default values.
7. Your unit is now ready for operation.

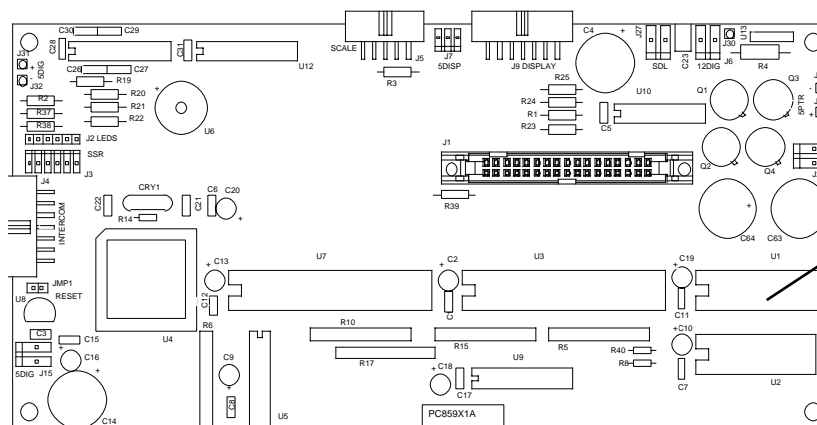

Printed Circuit Board Assembly

# SOFTWARE

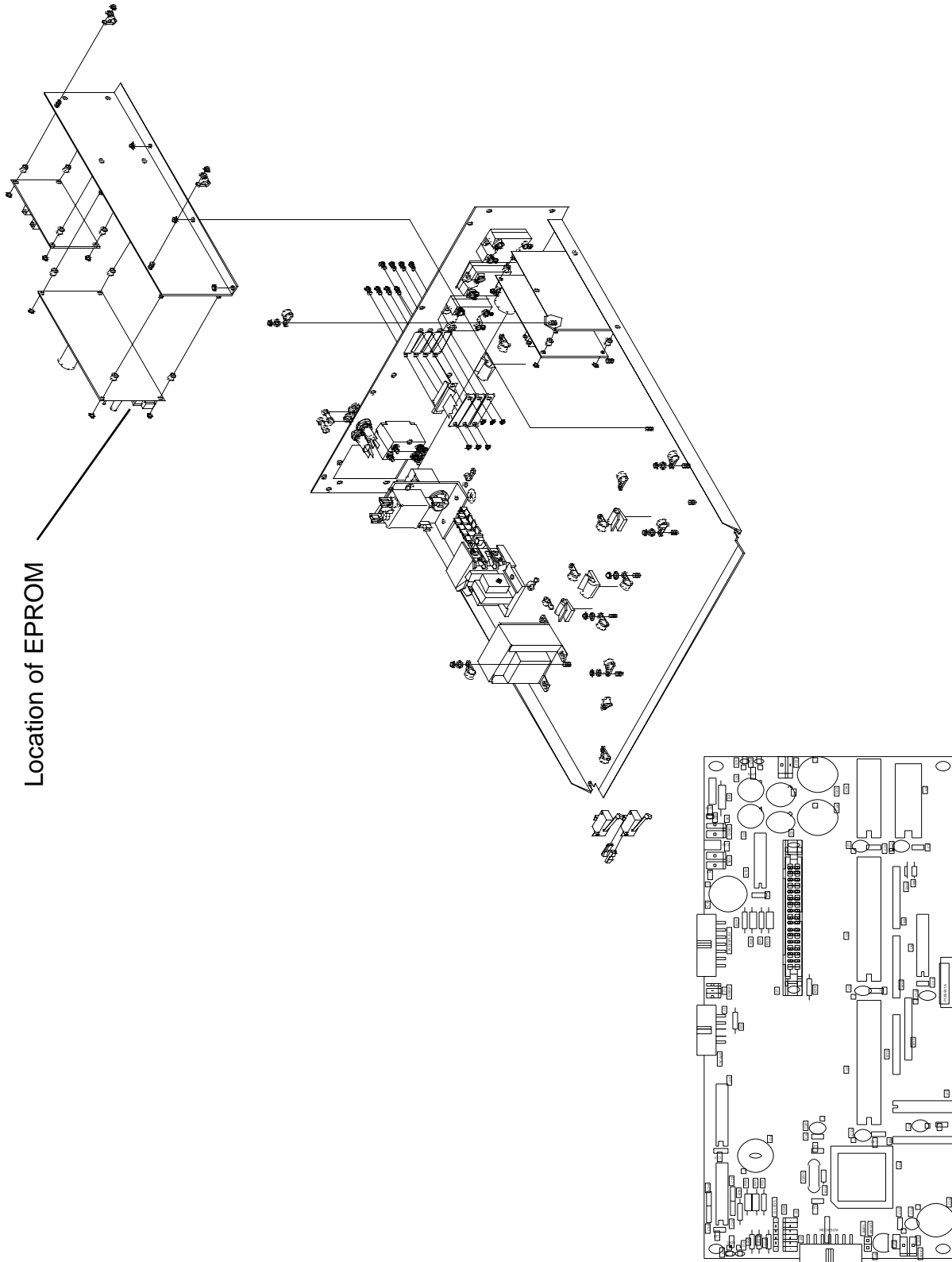

---

## Ordering Information

---

### Revision "I" Software Kit AY1087X3

- 1 ea. SC859X1 EPROM Labeled Rev. I Software
- 1 ea. Installation Instructions
- 1 ea. Set of Operation Manual Amendments

---

# Procedures

---

## Amendment

### TIMER PROGRAMMING & HIDDEN KEY PROCEDURES FOR REVISION "I" SOFTWARE

---

## Definition

Hidden Keys provide multiple use of the keypad. Hidden Key Procedures typically are used to access infrequently changed user variables and infrequently used diagnostic procedures. The access, procedure and exit are detailed under each key procedure. The furnace must be in the idle (non-programmable) mode to access the Hidden Keys.

Amendment #1 applies to Operation Manuals, Part Numbers LT859X1, LT945X1, LT945X3 and LT945X4 for NCAT Asphalt Content Tester.

---

## Programmable Timer

Heating the furnace to operational levels may require two or more hours of preheating but leaving the furnace on constantly may not be efficient, consuming both electricity and heating elements. To optimize your working hours, we have designed an automatic preheat timer into your asphalt testing furnace. This feature allows you to begin work immediately each day, but only run your furnace as much as necessary to complete your days work.

---

## Programming the Timer

The following directions will explain how to program the "wake-up" date and time into your asphalt furnace. This will determine exactly when the furnace will begin preheating to your setpoint temperature. We recommend that you set the time for at least 2-1/2 hours before you want to begin work.

1. Press the timer button on the key pad. The heating element will shut down at this time. The wake-up time will be displayed in the "Elapsed Time" display and the "wake-up" date will be displayed in the "Percent Loss" display.
2. Enter the "wake-up" date by inputting the



### Note

If you don't want to enter a "wake-up" date you can bypass this feature by simply pressing "ENTER" after you have pressed the timer button in step 1. Bypassing the date automatically converts the timer from a programmable 364 day timer to a 24-hour timer. This means that when the programmed "Time" is reached, the unit will begin heating, ignoring the "wake-up" date. The date needs to be set at 0.00 for this to happen.



**Note**

The timer format is European or Military time so to enter a wake-up time of 5:00 a.m. you would input 500 and then press ENTER. A wake-up time of 5:00 p.m. would be inputted as "17:00" then press ENTER. The start up time and date are now entered.

month and then the day. Example: May 16th would be entered 5/16. Then press ENTER. The "wake-up" date is now set.

3. You may now proceed to enter the "wake-up" time.

If at any time you wish to disable the timer, press the START/STOP button.

---

**Interrupting the Timer Mode**

(Same as before.)

---

**Inactivity Mode**

By using the hidden key feature with the "Timer" key, you can select the Inactivity Mode. This mode allows the furnace to "wake-up" at the programmed time and date, but if the user does not press any keys for a period of 4 hours, the unit will shut down and "In Ac" will be displayed in the chamber temp display. The unit will remain shut down until the user presses the START/STOP key. Pressing the START/STOP key will set the unit into its normal idle mode.

The Inactivity Mode is a valuable feature should the unit be placed in a remote location, and the operator is not able to return due to unexpected circumstances such as inclement weather. The unit will remain shut down until the user presses the START/STOP key.

---

**Test Interrupt/ Power Interrupt**

If the power to the furnace is interrupted during an ignition test, and then restored—the furnace will continue the test but will print the following information on the ticket:

```
[Results Invalid]
Test Interrupted
  Time: XX:XX:XX
```

The elapsed time will restart at 1 and continue to count up. The software will continue to monitor the weight loss and recognize the endpoint to end the test.

This feature will prevent smoke from entering the lab should a power interrupt occur. Once power has been

## PROCEDURES

```

HIDDEN
O KEY
Print Diff = Off
Print Ref = Off
Date = On
Time = On
NU = Off
Stable Print = Off
Non-PH      0.0 g
Non-PL      0.0 g
Interval = 1
Auto Print = Off
Print Options
RS-232 = 9600:N:8:1
Print Menu

Lock Switch is OFF.
Date=US 4/08/97
Time=Euro 10:26:13
Auto Tare = Off
Net = Off
Statistics Off
Function = None
g
Enabled Modes:
LFT is Off
Setup Menu

AZT=Off, Beep=Off
AL=3, Stb=.5 d
User Menu

GT8000 98101-34 Sr#1.6
Listing of Scale Var.
-----
Tested By:-----
Serial #:-----
Model #:-----

Time: ::
Date: --
Software:
-----
```

restored the blower will start up again to maintain air flow through the chamber. This will also prevent the user from prematurely opening the door.

The power interrupt feature also applies to the programmable timer. Should the power go off during the night while the unit is asleep and then come back on prior to the programmed “wake-up” time, the software will recognize the present time and “wake-up” at the correct programmed time.

### Auto Shut-Down Mode

Software can be toggled between Auto Mode and Manual Mode by performing a Hidden Temp Key Routine. In the Auto Mode, the unit will recognize the endpoint, stop the blower, print the results, and then BEEP once every 60 seconds until the operator presses the START/STOP key. This will unlock the door and disable the beep.

In the Manual Mode the unit will recognize the endpoint and place an asterisk by the endpoint. It will continue to run the test and beep until the operator presses the START/STOP button.

---

## O Key-Diagnostics:

Access: Depress the Power Switch to “ON” while simultaneously depressing the “O” key.

Procedure: Enter the diagnostic procedure for factory testing.

The furnace must be at room temperature and unloaded. Run time is approximately two hours. Upon accessing, the user variables will default to factory set variables in order to match the variables used in the factory test. You will need to prompt the initial test segments by depressing the START-STOP key to move to the next segment. Test segments requiring heat-up times automatically proceed to the next segment without prompting.

Exit: Depress Power Switch to "OFF" and then "ON" to return to normal operation.

---

### 1 Key-Print Out Paper Saver:

Access: Depress Power Switch to "ON" while depressing the 1 key simultaneously.

Procedure: Chamber temperature display will display PRN and the Percent Loss display will toggle "ON" or "OFF" as the access procedure is repeated. The new mode will be displayed for three seconds and then the furnace will return to normal operation.

Exit: Automatic

---

### 2 Key-Default:

Access: Depress the 2 key while simultaneously depressing Power Switch to "ON".

Procedure: DEF will be displayed for three seconds to indicate variables have been reset to factory values. The furnace will return to normal operation. Defaulting to factory values is a useful diagnostic tool as a comparison of current values vs. factory values can be made within minutes. Values can be printed by depressing ENTER while simultaneously depressing the Power Switch to the "ON" position.

Exit: Automatic

---

### 3 Key-Chamber Calibration Procedure

Equipment Needed: 1 ea. Digital Pyrometer with Penetration Probe, Sensor NIST Traceable. (Recommend Thermolyne PM20700 with TC405X4 Penetration Probe).

---

## PROCEDURES

- Setup:** Calibration consists of inserting a sensor penetrating through the covered stainless steel tube located adjacently to the control thermocouple. Entry is at the center rear of furnace chamber. The penetrating probe is needed to penetrate through the soft insulation. Probe insertion is at the same depth of the chamber control thermocouple. Cover probe entry tube after the calibration procedure has been completed. Do not place pyrometer on top of hot furnace. After inserting the test thermocouple penetration probe, set furnace at 538°C or standard method specified temperature. Allow furnace chamber to stabilize at set point in the idle mode. The maximum offset allowed before hardware calibration is required is +50°C.
- Access:** Depress 3 key while simultaneously depressing power switch to "ON".
- Procedure:** CHBR CAL will be displayed in the Percent Loss and Elapsed Time windows respectively. The Chamber Temperature window will display the actual chamber temperature which should be at or near set point temperature. Allow the furnace to stabilize at set point.
- Enter the temperature displayed in °C by the digital pyrometer by using the keypad. Press "ENTER". The new offset value will be used and the entered temperature will be displayed. The entered temperature is the temporary set point.
- The original set point will return upon exiting. The software has calculated and saved the new offset value, which will apply to all set points throughout the operating range.
- Exit:** Depress Power Switch to "OFF" and then "ON" to return furnace to normal use. Remove sensor probe and cover entry tube.

---

## 4 Key-Provides Entry to Balance Menus

- Access:** Depress 4 key while simultaneously depressing Power Switch to "ON".
- Procedure:** BAL will display in Chamber Temperature window. CAL will display in Percent Loss window. Entry allows you to change time and date settings, review and adjust balance variables, and calibrate balance. These topics are detailed under "Resetting the Balance" and Balance Calibration instructions.
- Exit:** Depress Power Switch "OFF" and then "ON" to return furnace to normal use.

---

## 5 Key-Filter Temperature Adjustment

- Access:** Depress 5 key while simultaneously depressing the Power Switch to "ON".
- Procedure:** Adjustment range is 0-900°C. Factory set point is 750°C. Chamber Temperature displays current set point. Percent Loss window displays FIL. Elapsed Time window displays SP for set point. Use the key pad to change the display to the new set point value. Depress "ENTER" promptly. This new set point value will be displayed.
- Exit:** Depress Power Switch to "OFF" and then "ON" to return furnace to normal operation.

---

## 6 Key-Disables Error Codes

- Access:** Depress 6 key while simultaneously switching the Power Switch to "ON".
- Procedure:** ERR will be displayed in the Chamber

Temperature window. "OFF" will be displayed in the Percent Loss window. The furnace will automatically return to normal operation within five seconds with the error codes deactivated.

Error codes are defeated to perform diagnostic procedures as to temporarily ensure continued furnace operation in the event of an error code.

Exit: Depress the Power Switch to "OFF" and then "ON" to return the furnace to normal operation with activated error codes.

---

## 7 Key-Displays Actual Filter and Chamber Temperatures:

Access: Depress the 7 key while simultaneously depressing the Power Switch to "ON".

Procedure: Chamber temperature will display actual chamber temperature. The Percent Loss displays actual filter temperature. Use for diagnostic purposes only.

Exit: Depress the Power Switch to "OFF" and then "ON" to return the furnace to normal operation.

---

## 8 Key-Serial Port Output Adjustment

Access: Depress the 8 Key while simultaneously depressing the Power Switch to "ON".

Procedure: SPC or SPn will display in the Chamber Temperature window for three seconds. SPC prints the serial output continuously. SPn prints the serial output only when the furnace is in the program mode. Accessing toggles the mode between SPC and SPn. The displayed mode is the active mode. Default is the SPC mode.

Exit: Automatically returns to normal operation within three seconds.

```
Software Version 1.7
5/05/98 11:34:49
Listing of Scale Var.
```

-----  
*Setra Balance Printout*

```
Print Diff = Off
Print Ref = Off
Date = On
Time = On
NU = Off
Stable Print = Off
Non-PH      0.0 g
Non-PL      0.0 g
Interval = 1
Auto Print = Off
Print Options
RS-232 = 9600:N:8:1
Print Menu
```

```
Lock Switch is OFF.
Date=US 4/04/97
Time=Euro 9:14:06
Auto Tare = Off
Net = Off
Statistics Off
Function = None
g
Enabled Modes:
LFT is Off
Setup Menu
```

```
AZT=Off, Beep=Off
AL=3, Stb=.5 d
User Menu
```

```
GT8000 98101-34 Sr#1.6
Listing of Scale Var.
```

-----  
*Ohaus Balance Printout*

## 9 Key-Disables Beep

Access: Depress the 9 Key while simultaneously depressing the Power Switch to "ON".

Procedure: The Chamber Temperature will display BEEP. The Percent Loss window will display "ON" or "OFF". The mode condition will display for three seconds. Accessing toggles the mode between "ON" and "OFF". The displayed mode is the active mode. The default mode is BEEP "ON".

The option to inactivate the beeper is useful for raw aggregate calibration when minute losses may cause the endpoint beeps to activate prematurely before the procedure has been completed. The key press beep is not disabled in the BEEP "OFF" mode.

## Weight Key-Prints Out Balance Variables

Access: Depress the weight key while simultaneously depressing the Power Switch to "ON".

Procedure: The Percent Loss Window will display SCAL. The Elapsed Time window will display L1S. The printout will generate automatically upon entering the printout mode. See Hidden Weight Key printout at left for balance variables. You can compare current printout with the example to ensure correct variables are entered.

Exit: The furnace will automatically return to normal operation after the printout is generated.

```
-----  
Auto Shutdown: Off  
RS232 Out: Continuous  
Printing: All data  
Beeper: On  
Inactivity Check: On  
Awake Date: 00-00  
Awake Time: 5:00  
Test Stability: 0.01%  
Calib. Factor: 0.00%  
Sample Weight: 1514g  
Chamber Offset: -50°C  
Filter Set Pt: 750°C  
Chamber Set Pt: 474°C  
Software: SC859X1 Rev 6  
-----
```

---

## Enter Key-Prints Out User Variables

- Access:** Depress the ENTER Key while simultaneously depressing the Power Switch to "ON".
- Procedure:** PRN will display in the Percent Loss window. User will display in the Elapsed Time window. The printout will generate automatically upon activating hidden key sequence.
- Exit:** The furnace will automatically return to normal operation after the printout is generated.

---

## Calibration Factor Key-Adjust or Check Test Stability Threshold at Test Endpoint

- Access:** Depress the Calibration Factor Key while simultaneously depressing the Power Switch to "ON".
- Procedure:** The stability threshold setting will be displayed in the Percent Loss window. The Elapsed Time window will display FLN. The value options are 0.01, 0.02, 0.03, 0.04%. Enter the new value via keypad. Observe the Percent Loss window as the new value is entered. The new value must be entered and the ENTRY Key must be depressed within five seconds.

ASTM Draft 6 specifies test endpoint completion when the measured mass loss does not exceed 0.01% over three consecutive one-minute periods. AASH-TO specifies endpoint completion when the mass loss does not exceed 0.02% over two consecutive one-minute periods. The test stability threshold value defines the endpoint. This value must match the standard specification you are applying. The test stability value is printed on the

User Variable Printout. See Hidden Key ENTER. An example of the printout is depicted on page 58.

Exit: Depress Power Switch to "OFF" and then "ON" to return furnace to normal operation.

---

### **Temp Key - Toggles from Auto Program Switching to Idle or Manual Program Switching to Idle at Endpoint**

Access: Depress TEMP key while simultaneously depressing the Power Switch to "ON".

Procedure: AU appears in the Chamber Temp display. The Percent Loss displays either "ON" or "OFF". If "OFF" is displayed, repeating access changes the display to AU "ON". You are now in the Auto Program Switching to Idle mode. Repeat Access again to return to the Manual Program Switching to Idle mode.

Auto Program Switching to Idle can increase the number of tests run per day. The operator's monitoring time is eliminated as the test results automatically print out at endpoint. The Manual Program Switching to endpoint is still available in the event continuous running is required after endpoint.

Exit: AU "ON" or "OFF" is displayed for approximately five seconds. The furnace automatically returns to idle.

---

### **Timer Key - Disables Inactivity Check**

Access: Depress the timer key while simultaneously depressing the power switch to "ON."

Procedure: The Chamber Temp will display InAc. The Percent Loss window

will display "ON" or "OFF." The Mode Condition will display for three seconds. Accessing toggles the mode between "ON" and "OFF." The displayed mode is the active mode.

---

### Active Keys

These keys activate a function when depressed. The furnace must be in the idle (non-programmable) mode.

---

### 0 Key-Tares the Balance

- Access: Depress "0" key. The balance will automatically tare to "0" grams in the balance display.
- Procedure: This mode is useful to perform the "lift test", as the balance must be tared before conducting test. See Glossary.
- The weight of the loaded basket assembly can be rechecked if the balance is tared prior to loading.
- Exit: Automatic

```
-----  
Elapsed Time: 46:00  
Sample Weight: 1520g  
Weight Loss: 111.8g  
Percent Loss: 7.36%  
Temp Comp: 0.20%  
Calib. Factor: 0.00%  
Bitumen Ratio: 7.74%  
=====  
Calibrated Asphalt Cnt  
7.16%  
=====  
Filter Set Pt: 750°C  
Chamber Set Pt: 538°C  
  
Tested By:-----  
  
Mix Type:-----  
  
Sample ID:-----  
Time: 10:26:57  
Date: 03-18-98  
-----  
**COPY**
```

---

### Enter Key-Duplicates Header Test Results

- Access: Depress the ENTER key.
- Procedure: The header and footer test results will print out for last test if no other key functions have been performed since printing of the last test results. The power switch must **not** be switched "OFF" and "ON" after the original test report is generated.
- This feature provides as many header copies of the last test results as needed by the operator.
- Exit: Automatic upon completion of printout.

---

## Bitumen Ratio

The Bitumen Ratio has been added to the Rev. "I" software. This test result is used in the United States and Europe. The Bitumen Ratio equation is detailed as follows:

$$\text{Bitumen Ratio} = \frac{(\text{Weight Loss}/\text{Sample Weight after ignition}) \times 100\% \text{ minus temperature compensation, minus correction factor.}}{1}$$

The Bitumen Ratio test results are printed in the header above the calibrated asphalt content for each test.

NOTE: When developing aggregate calibration factors, the desired output must be determined. If calibrated asphalt content value is used to develop the aggregate calibration factor, the Bitumen Ratio value should be ignored. The opposite is true if Bitumen Ratio value is used to develop aggregate calibration factor.

---

# Glossary

Balance Stability:	The small “S” will flash on and off at the left side of the balance display. When the “S” is shown, the balance is stable. It is normal for the “S” to flash early in the ignition procedure, as rapid sample weight loss occurs early in the firing procedure and diminishes as ignition nears completion. The “S” will not illuminate if the furnace is subject to vibration from other equipment in the lab. The stable indicator on the control panel is not related to the “S” balance stability indicator.
Calibration Factor:	Addresses the aggregate weight loss or gain which occurs during the ignition process. This loss or gain is not related to asphalt content loss and is added or subtracted from the asphalt content. Standard methods specify the procedure for determination. This calibration factor is entered by the operator.
Default:	Resets your current values to the factory values. See hidden keys 0 and 2.
Default Values:	These are factory values applied to each unit for testing during production. A printout of these values are supplied with each unit. Default values can be compared to your current values to assess correct entry of each value.
Error Codes:	Error codes are displayed to notify the operator of an out-of-specification condition or modification. Error codes range from E001 to E005 and E007 to E012. Explanations are detailed in the Operation Manual.

HMA:	Hot Mix Asphalt.
Idle Mode:	This mode is entered on startup after initialization. Revision "I" software automatically transfers from the program mode to the idle mode upon completion of the test. The furnace will idle at set point temperature in preparation for the next test. The blower is "OFF" in the idle mode.
Initialization:	This procedure sets up and configures the furnace for operator use when the Power Switch is depressed to "ON". Initialization time is approximately 5-15 seconds.
Lift Test:	This test measures the blower efficiency when the furnace is in an unloaded condition and is at room temperature. The operator is required to tare the balance, depress the start-stop key, and observe the balance display. Normal lift measurements are minus 3.5-10 grams.
NCAT:	National Center for Asphalt Technology.
Offset Value:	This value is the temperature difference between the stabilized chamber displayed temperature value and the chamber temperature verification value determined by the External Digital Thermometer.
Program Mode:	This mode is entered by depressing the start-stop key. The program mode is used to determine asphalt content of a HMA sample, calibration of the HMA sample, or raw aggregate.

---

## GLOSSARY

Temperature  
Compensation  
Factor:

This factor compensates for the loaded basket assembly weight reduction experienced when placed in the ignition furnace chamber at temperature. The Temperature Compensation Factor is automatically calculated by the furnace software. This factor must be employed in the ignition process to achieve acceptable precision and accuracy specified by standard methods. This factor is subtracted from the asphalt content.

Test Endpoint:

This is the point at which the HMA sample weight loss does not exceed the "Test Stability Threshold Setting" for three consecutive one-minute periods. Furnaces containing Rev. I software will end the test, asterisk the endpoint reading on the print-out, and switch from the program mode to the idle mode at endpoint if the Auto Program Switching to idle is employed.

Test Stability  
Threshold:

This adjustable variable determines the endpoint of the HMA sample mass loss. The test is complete when the measured mass loss does not exceed the stability threshold setting for three consecutive one minute periods. The stable indicator on the front control panel indicates the test stability threshold (endpoint) has been attained.

# Errors

---

## Red Display (Furnace)

*NOTE: Furnace ERROR Codes – RED display window. All error codes (unless explicitly noted) will cause the test procedure to stop. Microprocessor checks for error codes occur every second. It goes through the errors in order of importance starting at #1. If there are multiple errors occurring at the same time, the first error code will display on the unit.*

<b>Error Code</b>	<b>Cause</b>	<b>Solution</b>
E001	Chamber Thermocouple is open. Tip may be cracked at the weld and the crack may open with thermal expansion.	Thermocouple resistance is $\leq 1$ ohm. If it is open, replace it. If it is good check the connections at rear of furnace. Thermocouple leads are red (-) and yellow (+).
E002	Filter thermocouple open.	Follow above procedure for filter thermocouple.
E003	Chamber temperature limit of 675°C is exceeded. This will only come up when not running a cycle. This error is disabled while in the test program mode.	<p>Key routine #7 – will display the actual temperature. If the temperature readout is erratic, replace the analog board (bad optocoupler).</p> <p>If the readout is correct and the readout is 675°C, see if they recently changed any parts in the unit – especially the thermocouple. It could be a thermocouple with the leads labeled wrong (red wire = magnetic, yellow wire = non-magnetic) or thermocouple connected to the wrong connector. (i.e. Chamber thermocouple wiring connected to the filter thermocouple wiring.) Same with a SSR that was replaced, verify the wiring to make sure they were not switched.</p> <p>Check for shorted heating element.</p> <p>Check for shorted SSR.</p>
E004	Filter temperature limit of 975°C is exceeded.	Follow above procedure.
E005	Door interlock not functioning.	Is the unit brand new? Plunger is misaligned and should move freely up and down. (Plunger is located on the lower right hand corner of the unit.) Realign the position of the door hinge pins in the door hinge brackets. Check for a bent linkage bracket to adjust or a dent in the side of the unit. Straighten case if necessary.

---

## ERRORS

<b>Error Code (cont.)</b>	<b>Cause (cont.)</b>	<b>Solution (cont.)</b>
E005 (cont.)		<p>Solenoid valve is bad and not engaging the plunger. Turn unit on and start cycle to listen for the solenoid valve to active. Watch for movement in the plunger.</p> <p>To remove the door solenoid:</p> <ol style="list-style-type: none"><li>1. Disconnect the power to the unit and drop down the front control panel.</li><li>2. Remove the two wires on solenoid valve and two screws on the outside of the case.</li></ol> <p>Microswitch on right side of the unit has failed. This switch looks for the plunger to engage. 12VDC pulse engages the solenoid valve.</p> <p>Door switch on left side of unit - make sure it is connected.</p> <p>Main Logic Board has failed (Moss FET on board has failed.)</p>
E007	Analog to Digital Convert is not functioning properly. A component failure or faulty cable connection may cause this. This should only occur during a test.	<p>Turn the unit off and power back up. If E003 comes up then proceed with E003 information above.</p> <p>If E003 does not come up then replace the Logic PC Board or the Main PC Board.</p>
E008	The DTR signal from the balance is indicating the balance is either not ready or not connected.	<p>Reset the time and the date.</p> <p>Recalibrate the balance.</p> <p>Check the balance connection.</p> <p>Replace balance and/or cable WH859X3A. If the balance needs to be replaced, see BALANCE section of this manual.</p> <p>No display on balance display – OHAUS balance - check the fuse on the balance.</p>

<b>Error Code (cont.)</b>	<b>Cause (cont.)</b>	<b>Solution (cont.)</b>
E009	Set point is out of range. This is a temporary error to alert you that you have crossed the allowable boundary for the function you are setting.	The furnace will beep for 3 seconds while displaying this error and then return to normal operation. The setpoint will revert to its previous value. Chamber temperature is to be less than 674°C; Filter temperature is to be less than 900°C.
E010	Chamber thermocouple leads reversed. Thermocouple is a type "K". Polarity is coded as red (-) and yellow (+).	<p>If the thermocouple was just replaced, then reverse the leads.</p> <p>Check to see if E003 comes up while the unit is NOT running a program.</p> <p>If this error occurred during operation, perform hidden key routine #7 to verify the temperature. If the displayed temperature is erratic, replace the analog board.</p>
E011	Filter thermocouple leads reversed.	See above to proceed.
E012	Balance not communicating; weight, time and date not received.	Follow steps in E008. If the balance needs to be replaced, see BALANCE section of this manual.

---

## ERRORS

---

### Green display (BALANCE)

*NOTE: Balance error codes will be displayed in the green balance display. With most error codes below, power unit down and power back up to see if the error goes away. If it continues try to recalibrate, however, if the error will not clear, the balance will need to be replaced. See the BALANCE section of this manual. Two types of balances have been used in the NCAT furnace.*

---

#### OHAUS Balance

(Most common error codes. See Ohaus manual for the full list of error codes)

<b>Error Code</b>	<b>Cause</b>	<b>Solution</b>
3.0	Calibration Error - Incorrect or no calibration weight used for calibration.	Recalibrate with correct weights. Make sure all debris is off the top of the balance and the posts supporting the aluminum calibration plate are centered. Only the aluminum calibration plate should be used during the calibration procedure. If this error is only displayed when calibrating the unit, the software is bad and the unit needs to be replaced.
4.4	RS232 buffer is full. There is a bad connection in balance.	Double check all connections.
8.0	Hardware error causing an internal weight signal which is too low.	Check if the platform or platform support is off. If not, balance must be serviced.
EEEE	Displayed momentarily.	NCAT is getting power disconnect for a brief second and resetting itself.

---

#### SETRA Balance

(Error codes, unless specifically stated, refer to note at the top of the page.)

<b>Error Code</b>	<b>Cause</b>	<b>Solution</b>
HHHHH	Exceeds maximum specified load (5000 grams).	Reduce load to specified range.
LLLLL	Load does not meet minimum specified load requirements.	Increase load to specified range. Make sure the ceramic posts are centered and the plate is on top of them.
NOCAL	Unable to do span calibration (load not within 1% of cal weight, or weight unstable)	Replace scale.

<b>Error Code (cont.)</b>	<b>Cause (cont.)</b>	<b>Solution (cont.)</b>
PPPPPP	Strain on the DC power supply.	Disconnect printer to see if the error goes away. If it does, replace printer.
ProtEc	Calibration protect switch not in the PROTECT position during operation.	Replace scale.
REPlug	System not calibrated.	Replace scale.
OFLO	Internal arithmetic overflow.	Replace scale.
S Err	Processor stack overflow.	Replace scale.
In Err	Memory indexing error.	Replace scale.
UnABLE	Unable to process command (usually due to being in improper mode).	Replace scale.

---

## NCAT Troubleshooting with No Error Codes Displayed

<b>Error</b>	<b>Symptom</b>	<b>Action</b>
Keypad failure	The NCAT unit may beep or chirp in a non-rhythmic fashion.	Test keypad (See Equipment Test Procedure section.)
	The red displays will indicate characters (numbers and/or letters) that do not coincide with what should be displayed or what is normal.	Replace keypad (Serial number of NCAT needed to identify correct replacement part number of keypad.)
	NCAT performs a hidden key routine when initially powered on, yet end user did not initiate a hidden key routine.	
Blower motor failure	Results from lift test will not meet specifications.	Test blower motor by monitoring feed voltage.
	Full potential line voltage is applied to the blower motor in test mode but blower will not run.	Voltage will measure full potential line voltage on 945 series and 1087 series NCATs. 859 series units will measure full potential line voltage (if upgraded) or 120Vac.
	Motor may run, but makes abnormal noises.	Oil blower motor (See Maintenance Section.)  Replace blower motor. (Serial number of NCAT needed to identify correct replacement part number of blower motor.)
Low lift-test reading (Complaint)	A low lift-test reading is when performed by operators to signify routine maintenance needs to be performed. Lift-test readings should range from -3.0 to -8.2. (See Maintenance Section for proper lift test procedure.)	Follow the cleaning procedure steps. (See Maintenance Section)
		Test/replace the blower motor. (Serial number of NCAT needed to identify correct replacement part number of blower motor.)
		The insulation in the upper plenum may need to be replaced. If the blanket insulation is not tightly tucked against the top sides of the NCAT, air will not be forced through the five air baffle holes. Instead the air escapes around the outer edges resulting in a low lift test.

Error (cont.)	Symptom (cont.)	Action (cont.)
Smoke coming from control section during a burn	In addition to control section emitting smoke, a complaint of longer test/run times, a fowl odor, black colored substance running down the back balance support column(s), sample not burning out completely and inaccurate test results.	<p>Perform a lift test with and without the exhaust tubing attached. (See Lift Test Section.) If results are out of specification, follow the cleaning procedure steps. (See Maintenance Section)</p> <p>Check the door insulation for black streaks running from the edge of the insulation towards the center. This indicates the door is too loose and in need of tightening. (See Maintenance Section)</p> <p>Monitor the axial cooling fan located in the back of the control section. The cooling fan should be sucking ambient air into the control section from the room. It should not be pulling air out of the NCAT control section. Axial fan may need to be remounted properly or replaced.</p> <p>Test the afterburner element in the 1087 series units or the top element in the 945 and 859 series units. (See element equipment test procedure.) If this element is not heating properly the unit will not be able to breakdown fumes/soot generated during the run mode. The top plenum of the unit will clog in a very short time and soot will build up rapidly as a result. If this element tests okay, then test the solid state relay. (See SSR equipment test procedure.)</p> <p>In 1087 Series units, there is a 1" diameter hole cut in the back piece of insulation. Locate the hole in the lower left side of the back of the chamber and use a sturdy piece of wire to loosen any soot build up. The hole acts as a chimney and may clog up with soot. Replacement of this piece of insulation may be necessary.</p> <p>Ventilation system may be inadequate. (See Maintenance Section; Air Pressure.)</p>

---

## ERRORS

<b>Error (cont.)</b>	<b>Symptom (cont.)</b>	<b>Action (cont.)</b>
Tests never end (Complaint)	If the sample does not lose more than 15 grams at the end of the 15th minute, the software is programmed not to detect an endpoint and the test will run until stopped by the end user. (Written into software due to early aggregate calibration procedures.)	<p>Perform a test in which minute by minute test results are printed out. Examine the burn ticket &amp; note the weight loss at the 15th minute. If not greater than 15 grams, unit is performing as it should. (See Sample Ticket Section.)</p> <p>Perform a hidden key 2 routine and attempt to burn a 1500 gram sample. Initial sample may have been too large.</p> <p>Recalibrate balance or replace balance. (See Balance Section.)</p> <p>Inaccurate temperature indication on display. Verify chamber temperature with an external N.I.S.T. Pyrometer and probe. Calibrate temperature.</p> <p>Ensure samples are being leveled off in baskets. DO NOT MOUND SAMPLES, as the internal portions of the sample may not burn out Completely due to the lack of oxygen to burn.</p>
Burn ticket indicates the load actually gains weight (Complaint)	<p>Support posts may be touching or rubbing as may the ceramic plate or basket in the chamber.</p> <p>Evaluate basket. As baskets age, they may start to warp, especially when introduced in a hot chamber.</p>	<p>Ensure all are centered and try running another sample. (See Sample Ticket Section.)</p> <p>Warping may cause the basket to rub against the chamber. Basket(s) may need to be replaced.</p> <p>Recalibrate balance. (See Balance Section.)</p> <p>Replace the balance.</p>
Unit will not heat up but displays appear normal (Complaint)	If the area ambient temperature is below 50°F, the main microprocessor will not recognize the milli-volt signal generated by the thermocouples.	<p>Attempt to warm the tip of the chamber thermocouple by holding it in the flame of a match for 15 seconds. Close chamber door and see if unit starts to heat.</p> <p>Use a portable space heater to warm the electronics of the unit. Allow 15 to 30 minutes for NCAT to warm.</p>

<b>Error (cont.)</b>	<b>Symptom (cont.)</b>	<b>Action (cont.)</b>
	Test results inaccurate from sample to sample of the same source	Ensure samples are the same size (weight.) Methodology errors in sample splitting. Recalibrate balance or replace balance. Verify chamber temperature accuracy; recalibrate if necessary.

---

*REMINDER: Barnstead International has premixed samples of asphalt that can be sent to customers that have problems burning obtaining repeatable results and poor accuracy. Our samples are hand mixed at 5.0%. Our samples should be burned with a calibration factor of 0.0 at 538°C (chamber temp). Results will show 4.9% to 5.1% ac. in a fully functional NCAT.*

---

## Aggregates

Issues that can affect the accuracy and repeatability of the results not related to the NCAT:

1. Sample size consistency
2. Splitting errors
3. Moisture in mix
4. Type of material

Limestone, granite, and sandstone are the three most common base aggregates used. Granite is the hardest of these three. Sandstone is the softest with limestone being the medium. It is generally seen that harder aggregates burn more accurate than softer aggregates.

Dolomite is a base aggregate used in some parts of the United States (Indiana, Ohio). Dolomite based samples are difficult to burn with repeated accuracy in the NCAT. Off gases produced during burns cause mini like explosions in the chamber of the NCAT during a burn (like popcorn being popped). Barnstead has done extensive testing with Dolomite based samples. Copies of results are available upon request.

Hydrated Lime is sometimes added to to HMA to improve binder adhesion to certain aggregates. Hydrated lime will migrate to the aggregate during the burn, trapping some of the asphalt into the aggregate. In severe situations, the aggregate gradation may appear to actually gain weight after a burn is complete.

---

## Negative Air Pressure

Air temperature and altitude have an impact on air pressure, specifically the exhaust system on the NCAT. Negative air pressure refers to an “area” that has less atmospheric pressure exertion versus another. The “area” referred to is the room/building the NCAT is being installed versus the atmosphere (outside). If the atmospheric air pressure is greater than the room/building air pressure, you have a negative air pressure condition. The atmospheric pressure will attempt to offset the room or building pressure and equalize. The ventilation system

of the NCAT provides a direct path for atmospheric air pressure to enter the room/building when exhausted directly through an outside wall or the roof. The NCAT does have a 60CFM rated blower motor to aid the ventilation process, but in some situations, the pressure difference is too great and the blower motor can not prevent or stop the negative air pressure from occurring. Smoke generated for the NCAT will fill the room and/or the lift test will be low. This is a design issue in the buildings ventilation system, not the fault of the NCAT. There are a couple of options if the NCAT is to be installed at this location.

1. Open any doors or windows in the room. This may be enough to offset the pressure differences, allowing the NCAT to be operated properly.
2. Install a second blower motor in-line with the ventilation tubing from the NCAT. The second blower motor must be installed no closer than 10 feet from the unit. Barnstead/Thermolyne does not offer a selection of blower motors for this purpose and a motor would have to be purchased locally.
3. Checking the buildings ventilation system. This is would require consulting a HVAC technician.

---

## Displayed Letters/Numbers

“IN Ac” = Inactivity Mode. This mode is part of the timer, which allows the unit to automatically turn on and heat to set point temperatures. “IN Ac” will be displayed if the user does not press any keys for a period of four hours if the timer is set. Customer must press the start/stop key to return to the idle mode. Hidden Key TIME will also cause “IN Ac” to be displayed.

“PRN” = Printer. “PRN” will be displayed in the Chamber Temp window. On or Off will be displayed in the percent loss window to indicate if the printer is to print the header and footer of tests or minute by minute test results. Hidden Key 1 toggles the “PRN” On or Off. Hidden Key ENTER will also cause “PRN” to be displayed.

“DEF” = Default. “DEF” is displayed for 3 seconds in the Chamber Temp window to indicate the variables have been set back to factory default. Variables affected are chamber temperature (538C), filter temperature (750C), and stability threshold (.02%). Hidden Key 2 reset variables back to factory default.

“CHBR CAL” = Chamber Calibration. “CHBR CAL” will be displayed in the Percent Loss window and Elapsed Time window. Hidden Key 3 will cause “CHBR CAL” to be displayed.

“BAL” = Balance. “BAL” will be displayed in the Chamber Temp window. Hidden Key 4 will cause “BAL” to be displayed.

“FIL” = Filter. “FIL” will be displayed in the Elapsed Time window. Hidden Key 5 will cause “FIL” to be displayed.

“ERR” = Error. “ERR” will be displayed in the Chamber Temp window. Hidden Key 6 will cause “ERR” to be displayed.

“SPC” or “SPn” = Serial Port Output. “SPC” or “SPn” will be displayed in the Chamber Temp window for 3 seconds. Hidden Key 8 will cause “SPC” or “SPn” to be displayed.

“BEEP” = Beep. “BEEP” will be displayed in the Chamber Temp window. Hidden Key 9 will cause “BEEP” to be displayed.

“SCAL” = Scale. “SCAL” will be displayed in the Chamber Temp window. Hidden Key WEIGHT will cause “SCAL” to be displayed.

“FLN” = Stability Threshold. “FLN” will be displayed in the Elapsed Time window. Hidden Key CALIBRATION FACTOR will cause “FLN” to be displayed.

“AU” = Auto Program. “AU” will be displayed in the Chamber Temp window. Hidden Key TEMP will cause “AU” to be displayed.

**ERRORS**

Elapsed Time: 30:12  
 Sample Weight:1093g  
 Weight Loss: 57.7g  
 Percent Loss: 5.27%  
 Temp Comp: 0.00%  
 Calib. Factor: 0.29%

=====

Calibrated Asphalt Cnt  
 4.98%

=====

30	533	57.7	5.27
29	534	57.6	5.26
28	534	57.5	5.26
27	535	57.3	5.24
26	536	56.9	5.16
25	537	56.4	5.15
24	538	55.7	5.09
23	539	55.0	4.94
22	541	54.1	4.85
21	542	53.1	4.75
20	542	52.0	4.63
19	543	50.7	4.51
18	544	48.1	4.40
17	544	46.7	4.27
16	544	45.1	4.12
15	543	43.3	3.96
14	542	40.7	3.83
13	540	39.7	3.72
12	536	35.5	3.65
11	534	34.7	3.45
10	512	26.9	2.46
9	511	14.1	1.29
8	492	10.3	0.32
7	481	0.0	0.0
6	477	0.0	0.0
5	472	0.0	0.0
4	469	0.0	0.0
3	465	0.0	0.0
2	455	0.0	0.0
1	451	0.0	0.0

Example of an Ohaus balance configured incorrectly:  
 0.0 weight loss during the first 1-7 minutes, 0.00%  
 for the temperature compensation factor in the header  
 of the test.

-----:-----:-----:-----  
 T: Temp: Wt. Loss: %Loss  
 -----:-----:-----:-----  
 Filter Set Pt: 750°C  
 Chamber Set Pt: 538°C

OHAUS balance had incorrect parameter settings  
 causing this type of error. AZT was set to .5  
 AL was set to 1.  
 AZT should have been set to OFF and AL should  
 have been set to 3.

Tested by: \_\_\_\_\_

Mix Type: \_\_\_\_\_

Sample ID: \_\_\_\_\_

Time: 10:03:32

Date: 10-13-01

Elapsed Time: 30:12  
 Sample Weight:1093g  
 Weight Loss: 0.8g  
 Percent Loss: 0.03%  
 Temp Comp: 0.00%  
 Calib. Factor: 0.00%  
 Bitumen Ratio: 0.03%

=====  
 Calibrated Asphalt Cnt  
 0.03%  
 =====

30	533	0.8	0.03
29	534	0.8	0.03
28	534	0.8	0.03
27	535	0.8	0.03
26	536	0.8	0.03
25	537	0.8	0.03
24	538	0.8	0.03
23	539	0.7	0.03
22	541	0.7	0.03
21	542	0.7	0.03
20	542	0.7	0.03
19	543	0.7	0.03
18	544	0.7	0.03
17	544	0.6	0.02
16	544	0.6	0.02
15	543	0.6	0.02
14	542	0.6	0.02
13	540	0.6	0.02
12	536	0.6	0.02
11	534	0.6	0.02
10	512	0.5	0.02
9	511	0.5	0.02
8	492	0.5	0.02
7	481	0.5	0.02
6	477	0.4	0.01
5	472	0.4	0.01
4	469	0.2	0.01
3	465	0.2	0.01
2	455	0.1	0.01
1	451	0.1	0.01

An example of the time/date function of the balance not properly set. The decimal place is actually moved 4 digits to the left.

-----  
 T: Temp: Wt. Loss: %Loss  
 -----

Filter Set Pt: 750°C  
 Chamber Set Pt: 538°C

Tested by: \_\_\_\_\_

Mix Type: \_\_\_\_\_

Sample ID: \_\_\_\_\_

Time: 10:03:32

Date: 10-13-01



Elapsed Time: 30:12  
 Sample Weight:1093g  
 Weight Loss: 57.7g  
 Percent Loss: 5.27%  
 Temp Comp: 0.13%  
 Calib. Factor: 0.00%

=====  
 Calibrated Asphalt Cnt  
 4.98%

=====  
 30 533 14.7 1.99  
 29 534 32.2 3.14  
 28 534 57.5 5.26  
 27 535 108.6 8.81  
 26 536 56.9 5.16  
 25 537 56.4 5.15  
 24 538 107.2 8.80  
 23 539 55.0 4.94  
 22 541 54.1 4.85  
 21 542 1.14 2.33  
 20 542 17.6 2.01  
 19 543 50.7 4.51  
 18 544 48.1 4.40  
 17 544 175.2 9.98  
 16 544 45.1 4.12  
 15 543 43.3 3.96  
 14 542 0.05 0.01  
 13 540 39.7 3.72  
 12 536 175.1 11.4  
 11 534 12.1 2.44  
 10 512 26.9 2.46  
 9 511 14.1 1.29  
 8 492 10.3 0.32  
 7 481 102.5 3.31  
 6 477 10.1 2.22  
 5 472 17.2 0.02  
 4 469 15.0 1.12  
 3 465 22.1 1.11  
 2 455 0.23 0.02  
 1 451 0.21 0.00

Balance plate is catching or the support columns holding the balance plate is rubbing against the sides causing the balance to bounce in weight loss. The basket could also be rubbing the sides of the chamber.

-----  
 T: Temp: Wt. Loss: %Loss  
 -----

Filter Set Pt: 750°C  
 Chamber Set Pt: 538°C  
 Tested by: \_\_\_\_\_

Mix Type: \_\_\_\_\_

Sample ID: \_\_\_\_\_  
 Time: 10:03:32  
 Date: 10-13-01

**ERRORS**

Elapsed Time: 30:12  
Sample Weight: 1093g  
Weight Loss: 57.7g  
Percent Loss: 5.27%  
Temp Comp: 0.14%  
Calib. Factor: 0.29%

=====  
Calibrated Asphalt Cnt  
4.98%  
=====

30	533	57.7	5.27
29	534	57.6	5.26
28	534	57.5	5.26
27	535	57.3	5.24
26	536	56.9	5.16
25	537	56.4	5.15
24	538	55.7	5.09
23	539	55.0	4.94
22	541	54.1	4.85
21	542	53.1	4.75
20	542	52.0	4.63
19	543	50.7	4.51
18	544	48.1	4.40
17	544	25.7	4.27
16	544	14.2	3.89
15	543	10.3	3.32
14	542	9.9	2.21
13	540	9.2	2.01
12	536	8.9	1.99
11	534	8.4	1.54
10	512	8.1	1.02
9	511	6.2	0.95
8	492	5.2	0.81
7	481	5.1	0.76
6	477	3.2	0.45
5	472	2.1	0.24
4	469	0.9	0.05
3	465	0.7	0.04
2	459	0.2	0.02
1	451	0.1	0.01

The sample did not lose 15 grams in the first 15 minutes.  
This particular sample will run non-stop as a result!

-----:-----:-----:-----  
T: Temp: Wt. Loss: %Loss  
-----

Filter Set Pt: 750°C  
Chamber Set Pt: 538°C

Tested by: \_\_\_\_\_

Mix Type: \_\_\_\_\_

Sample ID: \_\_\_\_\_

Time: 10:03:32

Date: 10-13-01

---

# Equipment Test Procedure

## Removal of the Control Assembly (Bottom Section) in the 1087 & 1275 Series NCAT

The control assembly is the lower section of the furnace. It houses all the P.C. boards, relays, the balance, and wire assemblies. When the front control panel (keypad) is lowered, you can look into the electronic control housing. The control assembly, if properly disconnected, can be slid out of the back of the unit.

To disconnect the control panel:

1. Remove the eight screws along the lower, outside back wall secure the control assembly from the back. They are located from the lower left-hand corner, across the top of the control section, and the lower right-hand corner of the unit. See photo. Screw placement is indicated by white X's.

*Back of unit*



*8 screws to remove to slide out control panel.*

## EQUIPMENT TEST PROCEDURE

2. Lowering the front panel, a washer/nut assembly can be located at each corner (front right & front left, right behind the hinges the panel swings on). These nut assemblies need to be loosened because they hold down the bottom plenum of the control assemble. See photo. Nut/washer placement is indicated by white X's.

*Front of unit with control panel hinged downward*



*2 nuts/washers to loosen to slide control panel out of unit.*

3. After the 2 nuts are loose in front and all eight screws are removed from the back of the control assembly, you can slide the control assembly out of the back of the unit. (Notice the assembly will only slide back for about an inch. Then it will "get stuck". **Do not continue to "tug" on the assembly.** The various wire harnesses will stop the control assembly from being able to slide out completely. Jerking or tugging will cause wires to be separated from connectors!)

4. Next, unhook the wire harnesses that secures the control assembly in place. IT IS VERY IMPORTANT THAT YOU NOTE WHERE EVERY WIRE HARNESS IS CONNECTED BEFORE STARTING TO UNPLUG THEM. There are a total of TEN different wire harnesses in the front that need to be disconnected and one grounding strap. (See photo. Wire and strap placement is indicated by white X's.) Starting from the left (facing the unit), disconnect the following:

*Front of unit with control panel hinged downward*

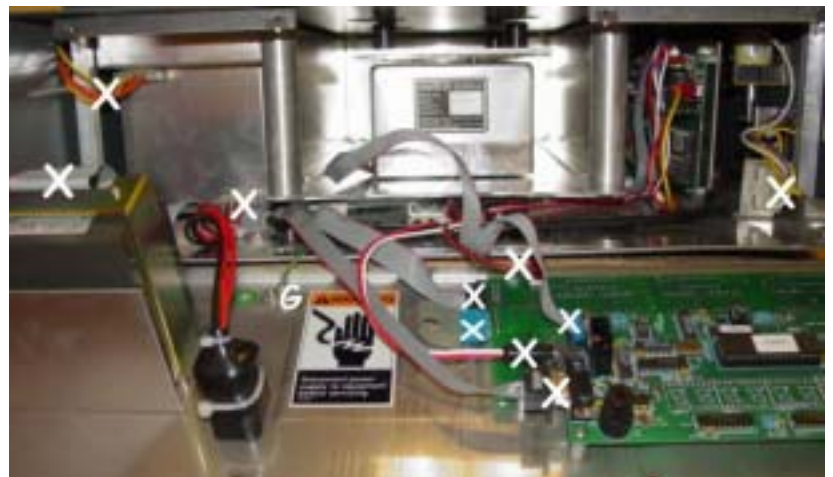

*10 wires to disconnect, plus grounding strap to slide control panel out of unit*

- a. Gray ribbon cable from the printer.
- b. 2 red wires and two black wires running from the green power switch that needs to be disconnected from the lower right hand corner of a silver "box" (red wires go towards the balance when plugging back in).
- c. On the upper left hand side of the same silver "box", you will find 2 orange and 2 yellow wires that need to be disconnected. (Two orange wires go towards the inside of the unit when you go to plug that connector back up.) They are the door switch wires.

---

## EQUIPMENT TEST PROCEDURE

d. There is a gray grounding-wire mounted to control assembly floor and the swing down control panel. One end needs to be released. The balance display board has 3 different wire harnesses plugged into it.

e. A small gray ribbon running from the balance to "P2" on the display board needs to be unplugged. (10-pin connector only plugs back in one way).

f. There is a red and white DC adapter labeled "P6".

g. A second gray ribbon connector labeled "P3". There is a special end on this harness that distinguishes it from the others. The "L" shaped red display board only has two wire harnesses that need to be removed.

h. A gray ribbon cable (14 pins). Located immediately next to the plastic ribbon cable for the keypad.

i. The second harness to unplug is a 3-pin connector. 2 little black and 1 little red wire makes up this assembly.

j. On the far right hand side the unit; one harness needs to be unplugged. This harness has 2 yellow wires, 1 purple wire, and 1 white wire. (Door switch and door-locking solenoid wires.)

5. There are two wire harnesses that need to be disconnected in the back of the unit. (See photo. Harness placement is indicated by white X's.)

*Back of unit - Control panel slid out 2.5"*



*2 wire harnesses to disconnect to slide control panel out of unit.*

- a. Locate a reddish-brown connector (for heating elements). The harness consists of 3 white wires and one green/yellow wire. Push the tabs on the sides and gently-lift the connector up to disconnect.
- b. The second wire harness in back consists of 4 white wires for the cooling fans. Lift the tab up and gently-pull the connector apart

---

## EQUIPMENT TEST PROCEDURE

6. Proceed to slide the control section out of the back of the unit. See photo below. As soon as the control section is approximately half way out, the thermocouple wires (Red and Yellow) will come into view and prevent the control section from sliding any further. The thermocouple connectors are green, the connectors also have a "C" for chamber, and "F" for filter printed on them, disconnect each one.

*2 wire harnesses to disconnect to slide control panel out of unit.*



*Control panel slid out 1/2 way*

7. The complete control assemble will slide all the way out now.



*Control section pulled from unit*

8. To reinstall the control panel, perform the same steps in the reverse order. (Remember to plug your thermocouple wires back in as you slide the control section back into the unit.)

*The biggest cause of failure when reinstalling the control section is having wire harnesses that are not plugged in properly. TIP: Do not ever "tug" on wires in an attempt to disconnect them. Some harnesses have tabs that need to be released in order for the harness to slide freely apart. TIP: Labeling wires prior to disconnecting will aid in reconnection.*



**Warning**

Unit should be at ambient temperature before attempting to replace the back wall insulation.



**Warning**

Unit should be disconnected from the power source before attempting to replace the back wall insulation.

---

## 1087 Series Back Wall Insulation Removal

---

### Procedure to remove/replace JC1087X3

Tools needed:

- Phillips screw-driver (power screw driver is available)
- Flat head screw-driver & Needle nose pliers
- Refer to drawings "ZD", "ZC, & "ZB" at the back of this manual for pictorials.

1. Disconnect unit from power source.
2. Detach the exhaust tubing from blower motor.
3. Position unit in an area where all four sides can be easily accessed.
4. Remove the back cover of the chamber section (CV 1087X10)
5. Remove the filter thermocouple (upper thermocouple - TC1087X1), taking care not to physically break the thermocouple (back of unit).
6. Remove the chamber thermocouple (lower thermocouple - TC859X1A), taking care not to physically break the thermocouple (back of unit).
7. Loosen the screws that secure the afterburner element lead wires on each terminal block (back of unit).
8. Loosen the screws that secure the top, both sides, and bottom heating element lead wires on each terminal block (back of unit).
9. Detach blower motor wire harness.
10. Remove the top cover assemble (CV1087X15 & CV1087X13)
11. Remove metal sheet cover (CV1087X1)

**Note**

Refer to the pictures and parts list in the back of this manual.

12. Remove blanket insulation (JC1087X7)
13. Remove insulation material (JC1087X4)
14. Remove afterburner element (EL1087X1)
15. Remove the filter (FL859X2)
16. Remove insulation material (JC1087X4)
17. Remove metal brace (BC1087X13)
18. Open chamber door
19. Remove top element (slide/pull out of chamber from the front) (EL1087X3)
20. Remove both side elements (slide/pull out of chamber from the front) (EL859X3 & EL859X4)
21. Remove the bottom element (slide/pull out of the chamber from the front) (EL1087X2)
22. Remove the back wall ceramic piece (PH412X1)
23. Remove the back wall insulation piece (JC1087X3)

Install the replacement JC1087X3 (position into place). By following the procedure to remove the JC1087X3 in the reverse order, the NCAT can be put back together.

---

## Heating Elements

**A) Heating Elements** (Quick & Simple Test)

*\*\*This test must be performed with the chamber at room (ambient) temperature.*

Equipment needed:

- None

- 1) Power up the NCAT unit.
- 2) Allow the NCAT to step through the startup countdown and go into the preheat mode. Note



### Caution

The internal walls are the actual heating elements and may be too hot to touch if the unit was allowed to heat for more than 30 seconds or the chamber was not at ambient condition to begin with.

when the CYCLE FILTER and CYCLE CHAMBER LED's illuminate on the front control panel.

- 3) Allow the NCAT to heat for 30 seconds.
  - a) The 30 seconds begin when the CYCLE FILTER and CYCLE CHAMBER LED's illuminate.
- 4) Power off the NCAT unit.
- 5) Open the chamber door and physically feel the top, sides, and bottom of the chamber with your hand. CAUTION: Element may be hot!
  - a) An element that is generating heat will be warm to the touch. An element that is not generating heat will be cold to the touch. Because of the series/parallel relationship of the elements in the circuit, this test method will not isolate which cold element is actually burned out and what cold element may still be good.

\*\*\*The afterburner element in the 1087 or 1275 series NCAT can not be tested in this manner because the surface area of the element is embedded in the top plenum of the chamber.

### **B) Heating Elements** (ohm check performed without power applied to the unit)

Equipment needed:

- Digital ohm meter (DMM)
- Phillips screw driver
- Flat-head screw driver
- NCAT Element Configuration print

- 1) Disconnect the NCAT unit from the power source.
- 2) Remove the back panel from the NCAT
  - a) 14 screws around the outer edges hold the back panel in place (4 on each side, top & bottom).
- 3) Loosen and remove the screws and nuts that hold down the element lead wire on each terminal block. Refer to page 94.

- 4) Open the chamber door and slide the top element straight out the front of the unit.
- 5) Remove the each side element in the same fashion. Refer to photos on page 94.
- 6) Remove the bottom element in the same fashion.
- 7) The afterburner element in the 1087 series units can remain in the unit
- 8) Measure the resistance between the element lead wires on each element with an ohmmeter. Refer to chart on page 95 to obtain element cold resistance value.
- 9) If the cold resistance of each element is off by more than 10 ohms, element replacement is needed.

\*\*\*When reinstalling the elements, the bottom element must be slid into position first, followed by each side & finally the top element.



*Element removal (top element shown)*

## N-Cat Element Configuration Print (220-240V & 208V) 859 & 945 Series Configurations

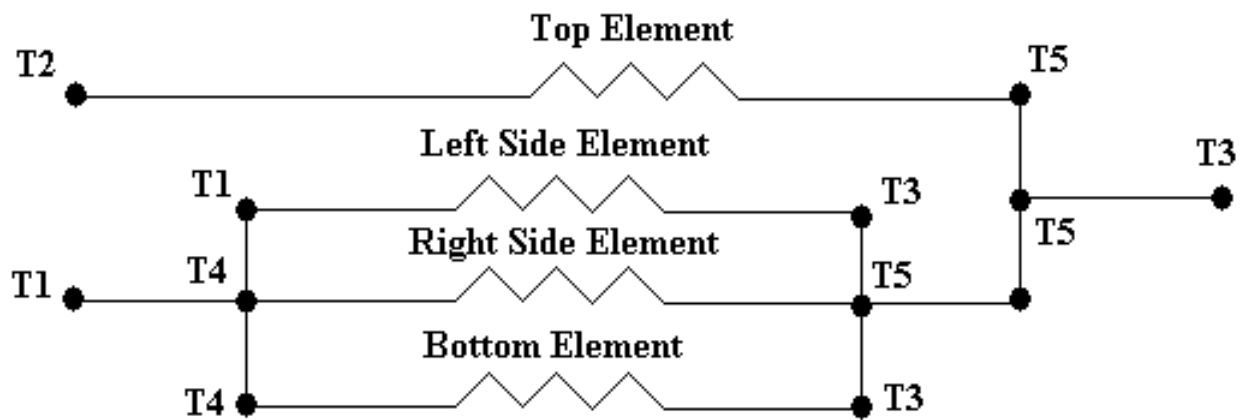

(Back of N-Cat w/cover removed)

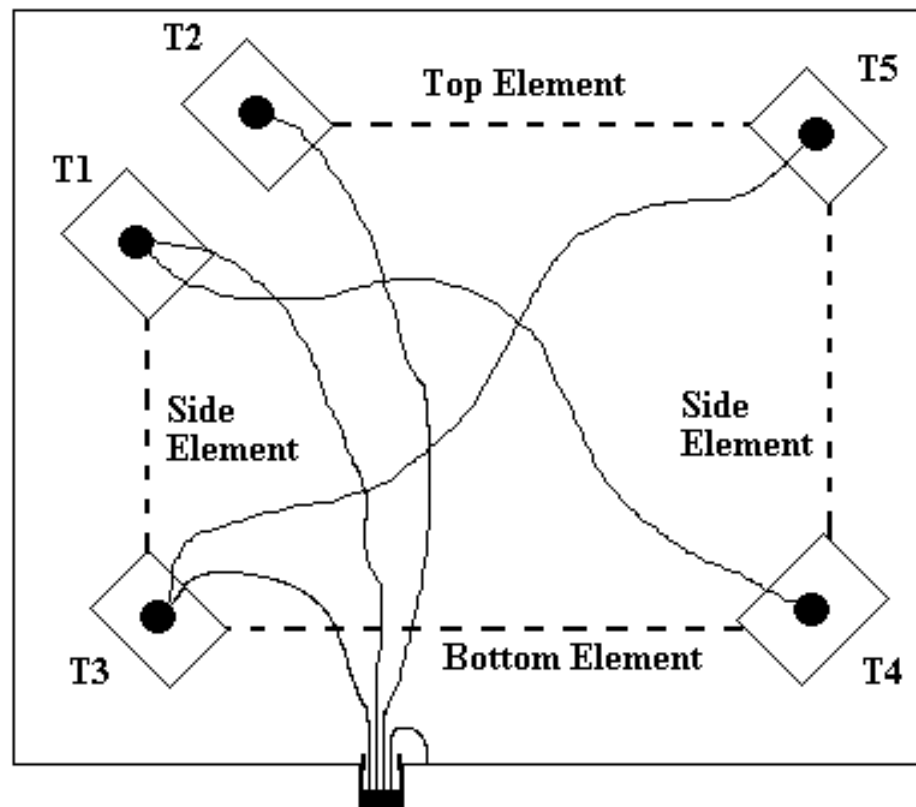

Picture not drawn to scale.

220-240V N-Cats are rated to draw 20 amps, 4800 watts

208V NO Cats are rated to draw 23 amps, 4800 watts

## N-Cat Element Configuration (220-240V & 208V) 1087 & 1275 Series High Amp Configuration Print

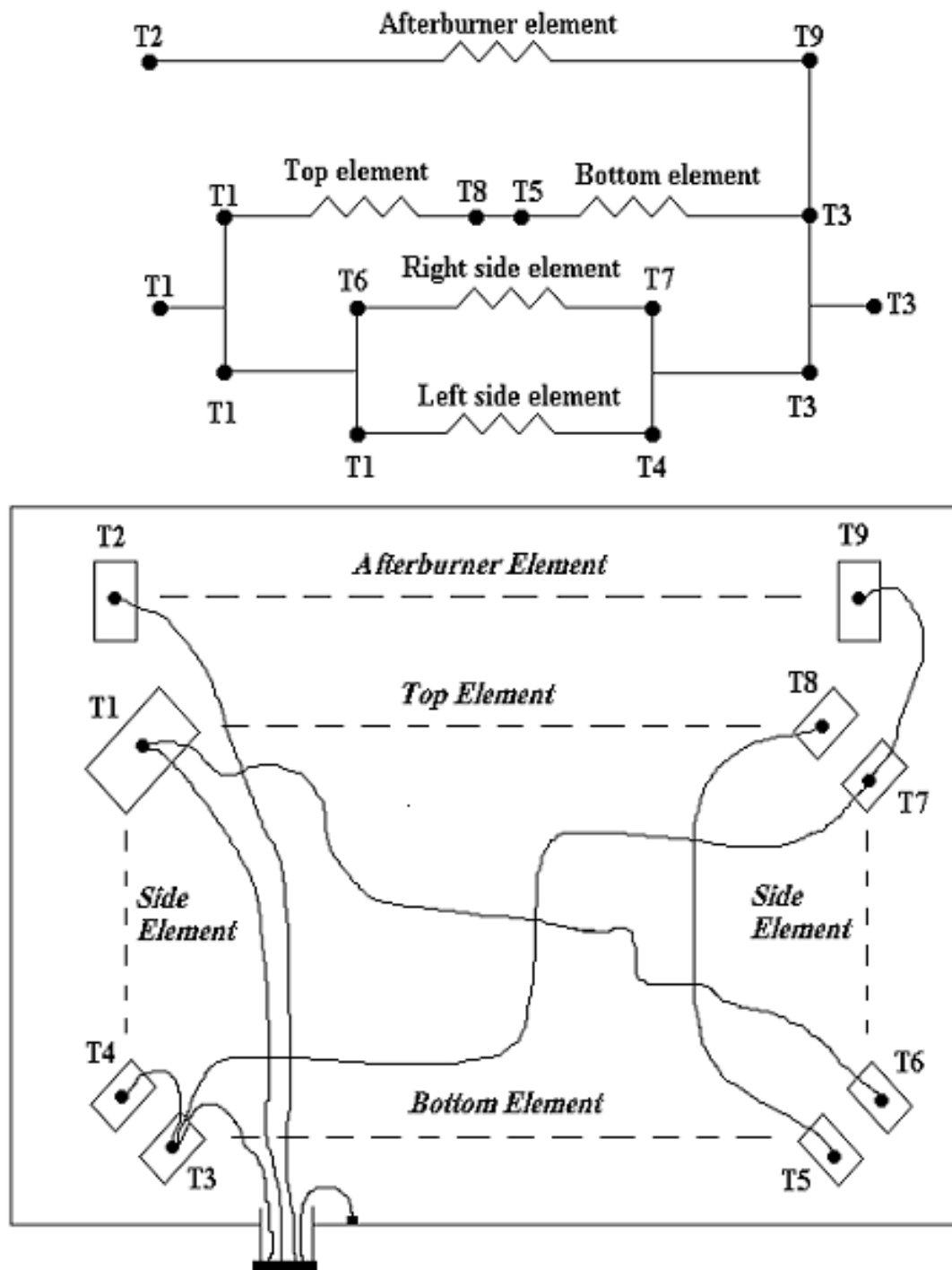

Picture is not drawn to scale, but represents how the back of an N-Cat will physically appear with the back cover removed. Excluded from the picture are the fan terminal block, thermocouple terminal block, thermocouples, and the vent port.

220-240V N-Cats are rated to draw 27 amps, 6379 watts in the high amperage config.  
208V N-Cats are rated to draw 28 amps, 5757 watts in the high amperage config.

5-14

## EQUIPMENT TEST PROCEDURE

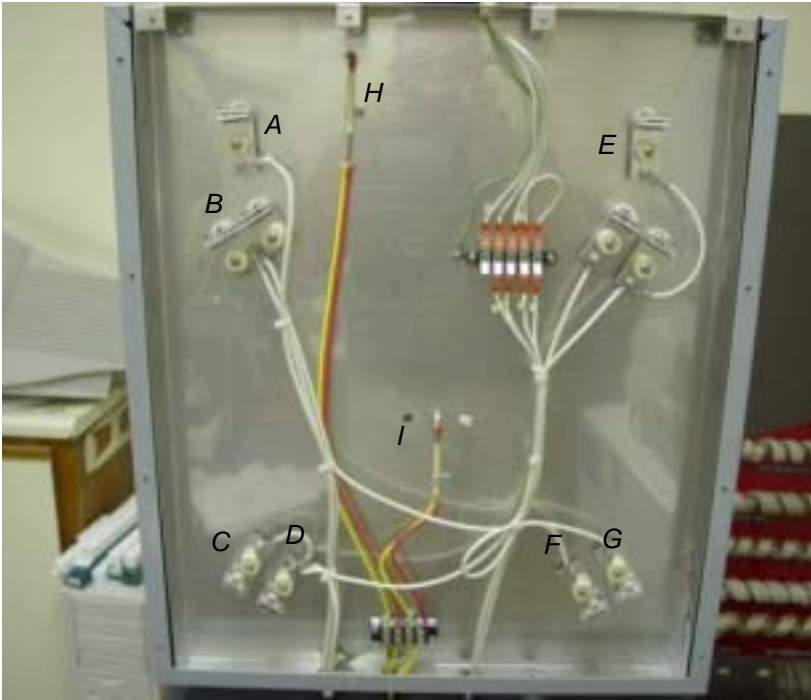

<u>Key</u>	<u>Description</u>
A	Element terminal blocks
B	Element terminal blocks
C	Element terminal blocks
D	Element terminal blocks
E	Element terminal blocks
F	Element terminal blocks
G	Element terminal blocks
H	Filter thermocoupler
I	Chamber thermocoupler

1087 or 1275 series back view

Element terminal block close up



Element lead wire

---

## Element Part Numbers & Cold Resistance

**Series 1087 & 1275**

<b>Part Number</b>	<b>Description</b>	<b>Voltage</b>	<b>Cold Resistance</b>
EL859X3	Right Side	All Voltages	55 Ohms
EL859X4	Left Side	All Voltages	55 Ohms
EL1087X1	Afterburner	220-240V	36 Ohms
EL1087X2	Bottom	220-240V	10 Ohms
EL1087X3	Top	220-240V	10 Ohms
EL1087X4	Afterburner	208V	30 Ohms
EL1087X5	Bottom	208V	8 Ohms
EL1087X6	Top	208V	8 Ohms

**Series 859 & 945**

<b>Part Number</b>	<b>Description</b>	<b>Voltage</b>	<b>Cold Resistance</b>
EL859X1	Top	220-240V	36 Ohms
EL859X2	Bottom	220-240V	55 Ohms
EL859X3	Right Side	220-240V	55 Ohms
EL859X4	Left Side	220-240V	55 Ohms
EL859X5	Top	208V	36 Ohms
EL859X6	Bottom	208V	55 Ohms
EL859X7	Right Side	208V	55 Ohms
EL859X8	Left Side	208V	55 Ohms

NOTE: Elements must be electrically isolated from one another for accurate resistance measurements to be taken. Remove element lead wires (back of unit) to properly isolate. Note correct orientation of wires prior to removal to reconnect properly.

## N-Cat Solid State Relay Connections

The solid state relays (p/n RYX34) are mounted on the back wall of the control section of the furnace.

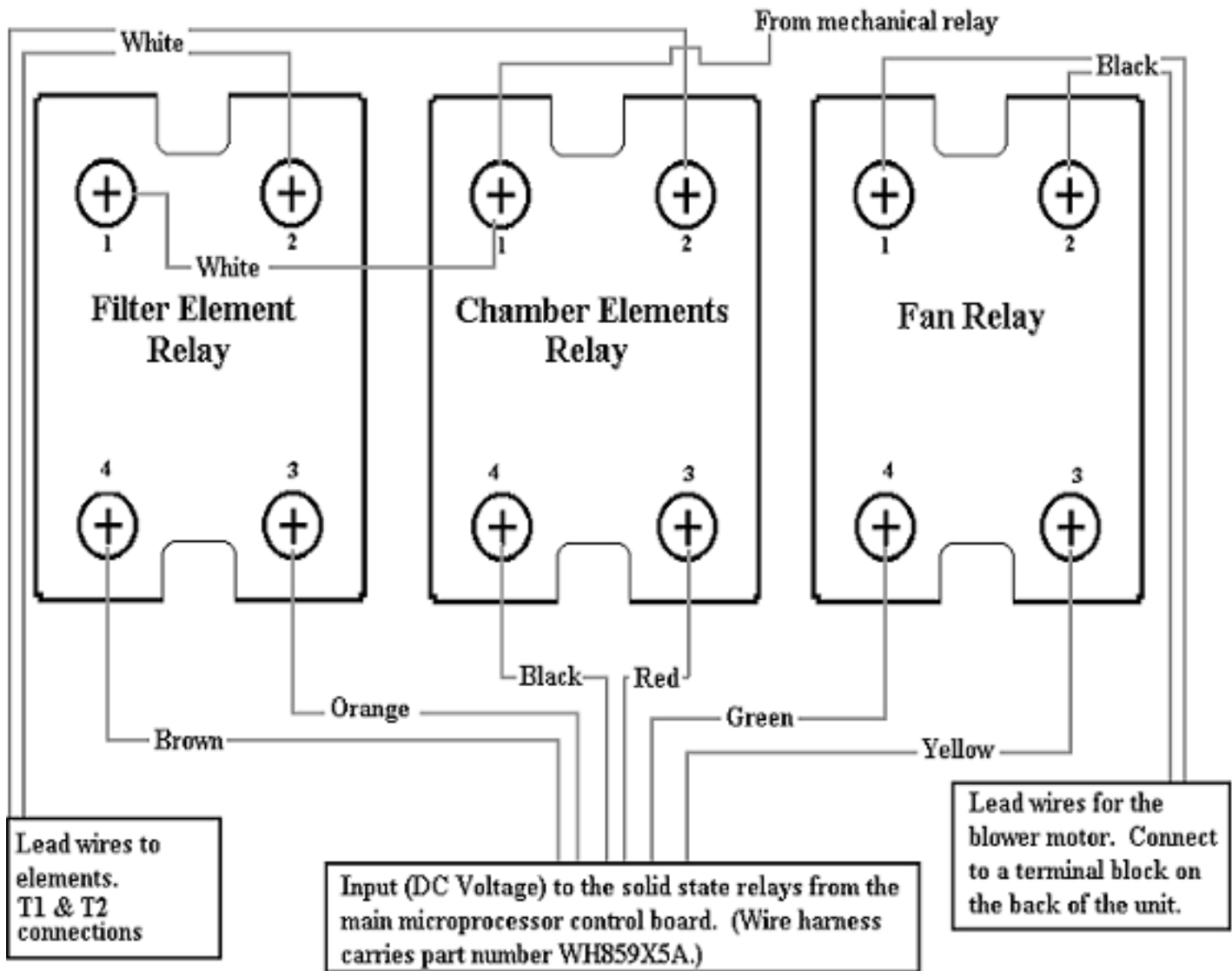

5-17

## N-Cat Element Configuration (240V Units ONLY!) 1087 & 1275 Series Low Amp Configuration Print

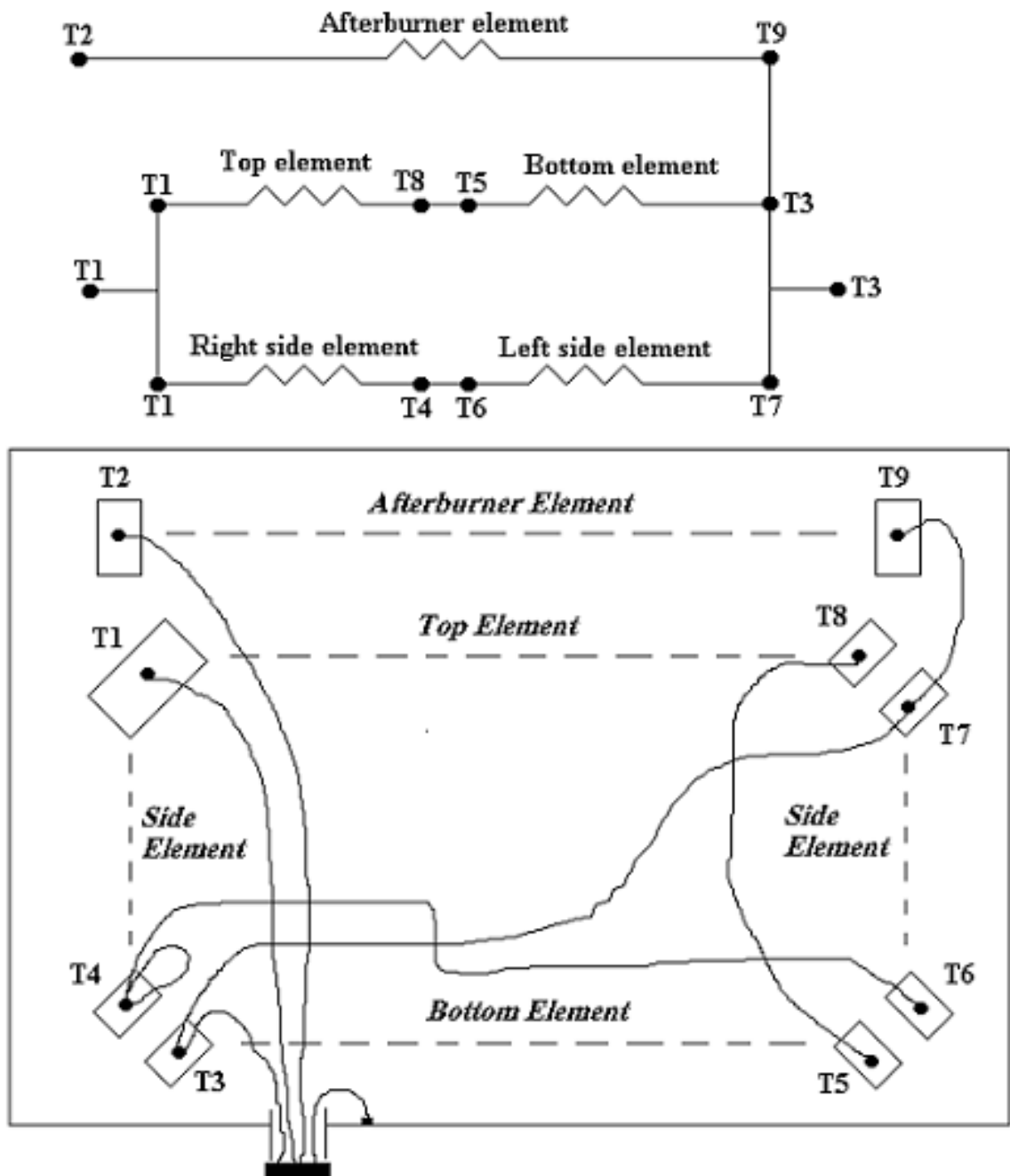

Picture is not drawn to scale, but represents how the back of an N-Cat will physically appear with the back cover removed. Excluded from the picture are the fan terminal block, thermocouple terminal block, thermocouples, and the vent port.

220-240V N-Cats are rated to draw 20 amps, 4879 watts in the low amperage config.

**\*\*208V N-Cats should not be attempted to run in low amperage configurations!**

5-15

## EQUIPMENT TEST PROCEDURE

1087 or 1275 series back view

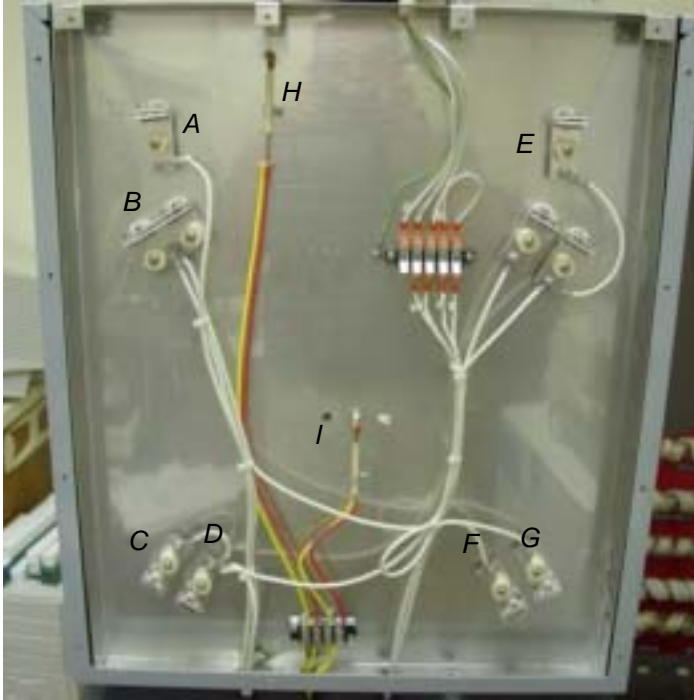

<u>Key</u>	<u>Description</u>
A	Element terminal blocks
B	Element terminal blocks
C	Element terminal blocks
D	Element terminal blocks
E	Element terminal blocks
F	Element terminal blocks
G	Element terminal blocks
H	Filter thermocoupler
I	Chamber thermocoupler

## Thermocouples

The NCAT utilizes two type K thermocouples. One thermocouple is routed into the back of the chamber. The other is routed into the top plenum (filter).

A type K thermocouple generates a millivolt signal. As the temperature rises in the chamber and filter section, the millivolt signal generated by the thermocouple increases. The generated millivolt signal is utilized by the main microprocessor to detect chamber and filter temperature changes.

A type K thermocouple is manufactured with nickel-chromium and nickel-aluminum wires and has definite polarity (positive and negatively charged wires). The negative wire has a RED insulator sleeve. The positive wire has a YELLOW insulator sleeve and a (+) sticker. It is also marked with a black indicator mark on the terminal end of the actual wire itself. Barnstead International recommends replacing the chamber and filter thermocouples every 12 months.

### A) Chamber Thermocouple

Equipment needed:

- Digital ohm meter or continuity tester
- Phillips screw driver

- 1) Disconnect the NCAT from the power source.
- 2) The chamber must be at ambient temperature to properly test the thermocouple. Allow unit to cool to ambient if necessary.
- 3) Remove the back panel from the NCAT.
  - a) 14 screws around the outer edges hold the back panel in place (4 on each side, top & bottom).
- 4) Disconnect the chamber thermocouple from the terminal block located near the middle/bottom of the back of the chamber.
  - a) The thermocouple has a yellow and red wire that run lengthwise up the back of the chamber wall, entering into the chamber approximately half way up the back wall.

b) This will electrically isolate the thermocouple from the rest of the circuitry.

c) It is important to label or note the color of the wire at the terminal block connection for polarity purposes.

5) Using a continuity tester, measure across the lead wires of the thermocouple.

a) A good thermocouple will have a very low resistance measurement or continuity.

6) Replace the thermocouple if it does not exhibit low resistance or continuity.

#### **B) Filter Thermocouple**

Equipment needed:

- Digital ohm meter or continuity tester
- Phillips screw driver

1) The filter thermocouple is tested in the same manner as the chamber thermocouple.

a) The filter thermocouple is connected to the same terminal block located near the middle/bottom of the back of the chamber. However, the lead wires run lengthwise up the back wall of the chamber, protruding into the NCAT near the very top.

2) Disconnect the yellow and red lead wires from the terminal block. This will electrically isolate the thermocouple.

a) It is important to label or note the colors of the wires at the terminal block connection for polarity purposes.

3) Using a continuity tester, measure across the lead wires of the thermocouple.

4) A good thermocouple will have a very low resistance measurement or continuity.

- 5) Replace the thermocouple if it has high resistance or no continuity.

\*\*Do not attempt to connect a voltmeter in parallel with either thermocouple, attempting to monitor the millivolt-generated signal. A meter will load the circuit, resulting in inaccurate measurements.

### **Thermocouple Drawing**

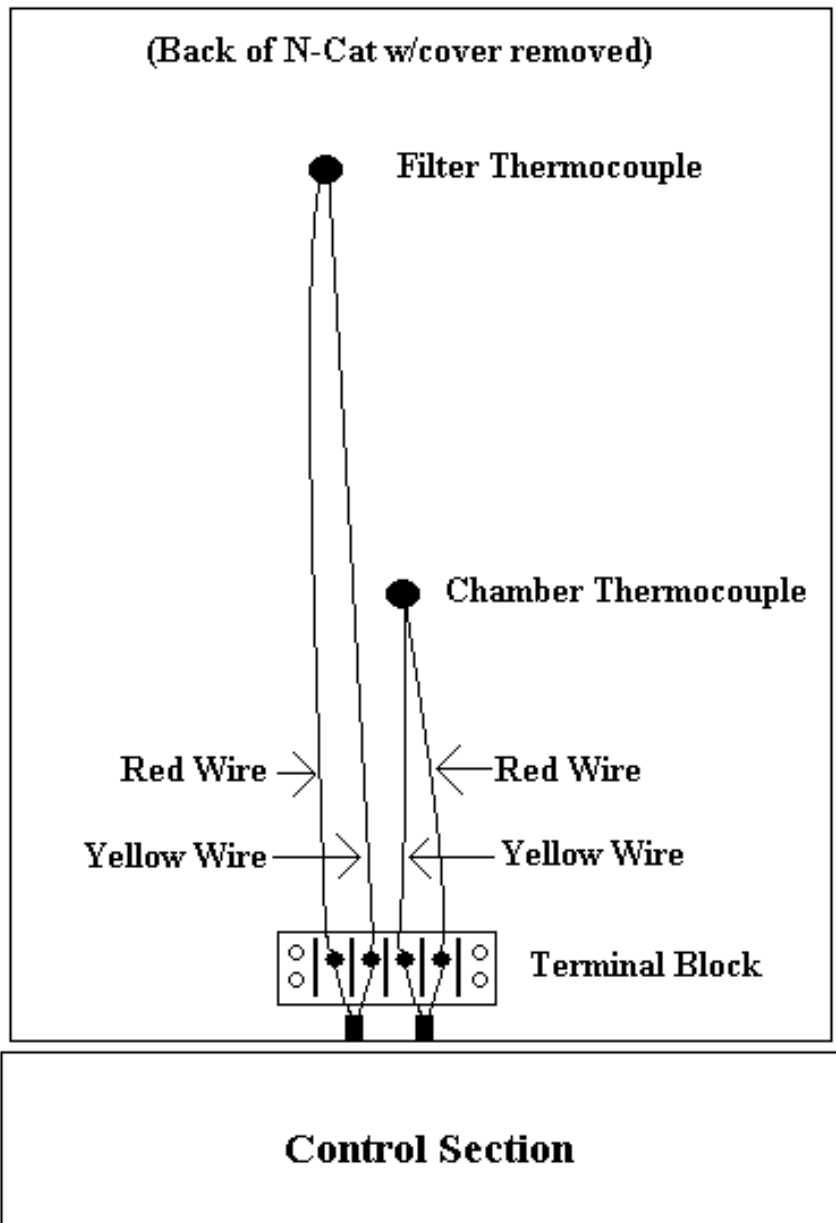

## Solid State Relays

There are a total of three solid-state relays in the NCAT. All three are located in the lower control section. Refer to photo of keypads on page 38. The solid state relays, activated by a 5 - 15Vdc signal from the main micro-processor P.C. board, act as switches that allow AC voltage to the chamber heating elements, filter element (afterburner), and blower motor (exhaust fan).

### A) Solid State Relay

Equipment needed:

- Digital voltmeter (DMM)
- Phillips screw driver

- 1) Disconnect the NCAT unit from the power source.
- 2) Remove the eight screws from the back of the control section.
  - a) There are 4 screws along the top of the control section and 2 on each side.
- 3) Lower the control panel (keypad) in the front of the NCAT.
  - a) There are 4 screws along the top of the control panel.
  - b) The control panel hinges from the bottom.
- 4) Loosen two nuts on the bottom, front edge of the control section.



- a) Each nut is physically located 1/2" to 1" directly behind the hinges. These nuts secure the control section to the front of the NCAT.
- 5) The control panel will slide out from the back side of the NCAT (Approximately 2" out from the unit.)
  - a) It is important not to pull the control section too far back with force, as several wire harnesses are still connected securing the control section in the NCAT.
- 6) The solid-state relays are now visible, mounted on the back wall, on the lower left side (a heat sink device is mounted on the outside of the NCAT). See photo on previous page.
  - a) The relay on the far left side is for the blower motor (exhaust fan). This relay will have two black wires connected to pins "1" and "2"; a yellow wire to pin "3"; and a green wire to pin "4".
  - b) The relay in the middle is for the chamber elements. This relay will have two white wires connected to pins "1" and "2"; a red wire to pin "3"; and a black wire to pin "4".
  - c) The relay on the right side (near the center of the furnace) is for the filter element (afterburner). This relay will have two white wires connected to pins "1" and "2"; an orange wire to pin "3"; and a brown wire to pin "4".
- 7) Connect the voltmeter leads to terminal pins number 3 and 4 of the solid-state relay. **CAUTION:** You will also be measuring live voltage, a potential shock hazard!
  - a) Each relay has 4 screw terminals, each labeled "1", "2", "3", "4". Terminal pins "1" and "2" on all three relays are considered the output and will only have AC voltage across them at various times of operation. Terminal pins "3" and "4" on all three relays are considered the input and will only have DC voltage across them at various times of operation. Pin "3" is the DC

positive terminal. Pin "4" is the DC negative terminal. Refer to page 96.

- 8) Power on the NCAT unit.
- 9) Allow the NCAT to step through the startup countdown and go into the preheat mode.
- 10) Note if the CYCLE FILTER and CYCLE CHAMBER LED's illuminate on the front control panel.
  - a) These LED's indicate the main microprocessor control board is attempting to apply power to the solid-state relays. If they are not illuminated, the solid-state relays should not have power applied to them and the main logic board may be defective.
- 11) How to determine if a solid-state relay is defective:
  - a) A solid state relay can be considered good, if the input of the relays (pins "3" and "4") have a 5 to 15Vdc signal applied across them and at the same time no AC voltage can be measured across pins "1" and "2".
  - b) A solid-state relay is also considered good, if the input of relay, pins "3" and "4", have no DC voltage signal applied across them and at the same time an AC voltage can be measured across pins "1" and "2".
  - c) A solid state relay is considered defective, if the input of the relays (pins "3" and "4") have a 5 to 15Vdc signal applied across them and at the same time full potential line voltage (AC) can be measured across output pins "1" and "2".
- 12) To test the blower motor (exhaust fan) solid-state relay, activate the blower motor by pressing the start/stop key to initiate a cycle run. (The blower motor is not activated in the preheat mode. Only when a cycle is being run in the test mode!) If the blower motor turns on, your

## EQUIPMENT TEST PROCEDURE



solid-state relay is working properly. Taking voltage measurements at this point is not necessary. However, if the blower motor does not run or is running while the NCAT is in the preheat mode, the solid-state relay may be defective. Take voltage measurements as described in step 11 to determine if the solid-state relay is defective.

### Keypad

#### A) Keypad

Equipment needed:

- Phillips screw driver
- Jumper wires or needle nose pliers

- 1) Disconnect the NCAT unit from the power source.
- 2) Lower the control panel by removing the 4 screws along the top edge. Control panel hinges downward.
- 3) Locate and disconnect keypad from J2 terminal of display board.
- 4) Reconnect the NCAT to the power source.
- 5) Use jumper wires or needle nose pliers to short two pins together on the J2 display board to simulate pressing a key. (Use the matrix chart below to identify what to pins to short out to simulate a key-stroke.)

a) The J2 terminal is an 8 pin electrical connection point. Connection terminal is orientated such that pin 1 is nearest D7 and pin 8 is nearest the J1 connection terminal.

b) Matrix chart:

7 Key	•				•			
8 Key		•			•			
9 Key			•		•			
Temp Key				•	•			
4 Key	•					•		
5 Key		•				•		
6 Key			•			•		
Weight Key				•		•		
1 Key	•						•	
2 Key		•					•	
3 Key			•				•	
Cal. Key				•			•	
Timer Key	•							•
0 Key		•						•
Start/Stop			•					•
Enter Key				•				•
	Pin 1	Pin 2	Pin 3	Pin 4	Pin 5	Pin 6	Pin 7	Pin 8

# Keypad Layout for 859/945 Series N-Cat Asphalt Furnace

Models: F85930 & F85938 (-33)

Replacement p/n = DL859X11A

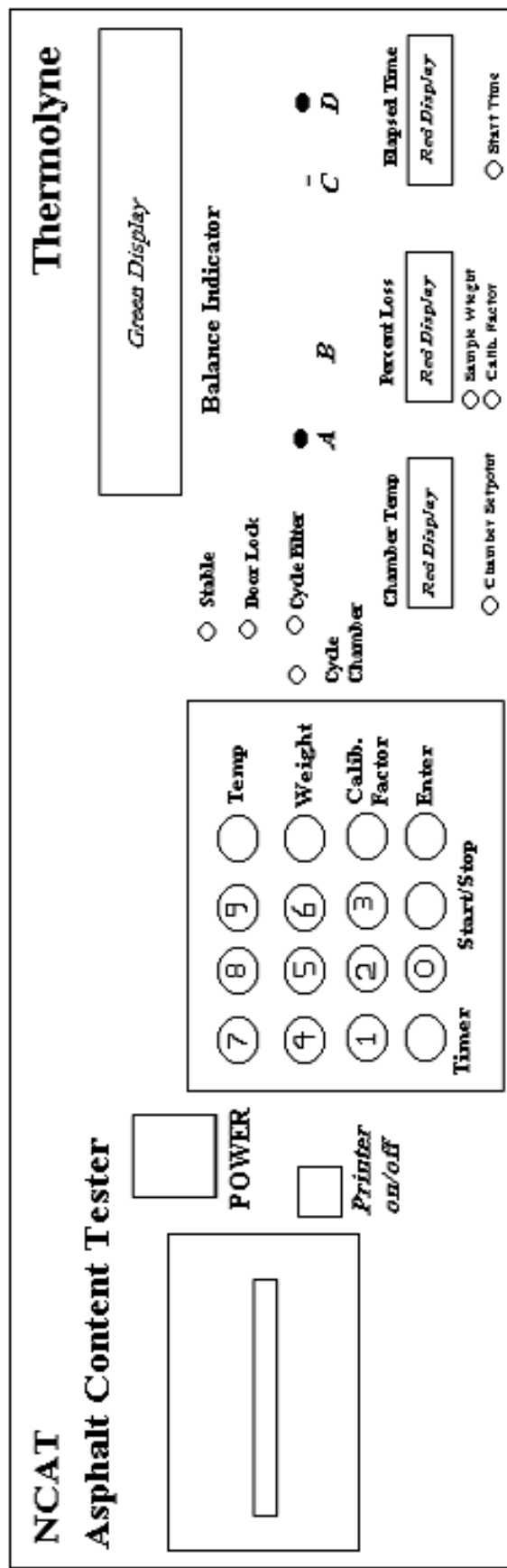

## Ohaus Balance Location Ports

When attempting to set the time/date or calibrate the OHAUS balance, please refer to this drawing for balance port location reference.

- A = Print Key
- B = Mode Key
- C = Off Key
- D = On/Tare Key

PT859X7 = Balance Calibration Plate

# Keypad Layout for 1087 Series N-Cat Asphalt Furnace

## Models: F85930, F85938, F85930-33

REPLACEMENT PART NUMBER =DL1087X8

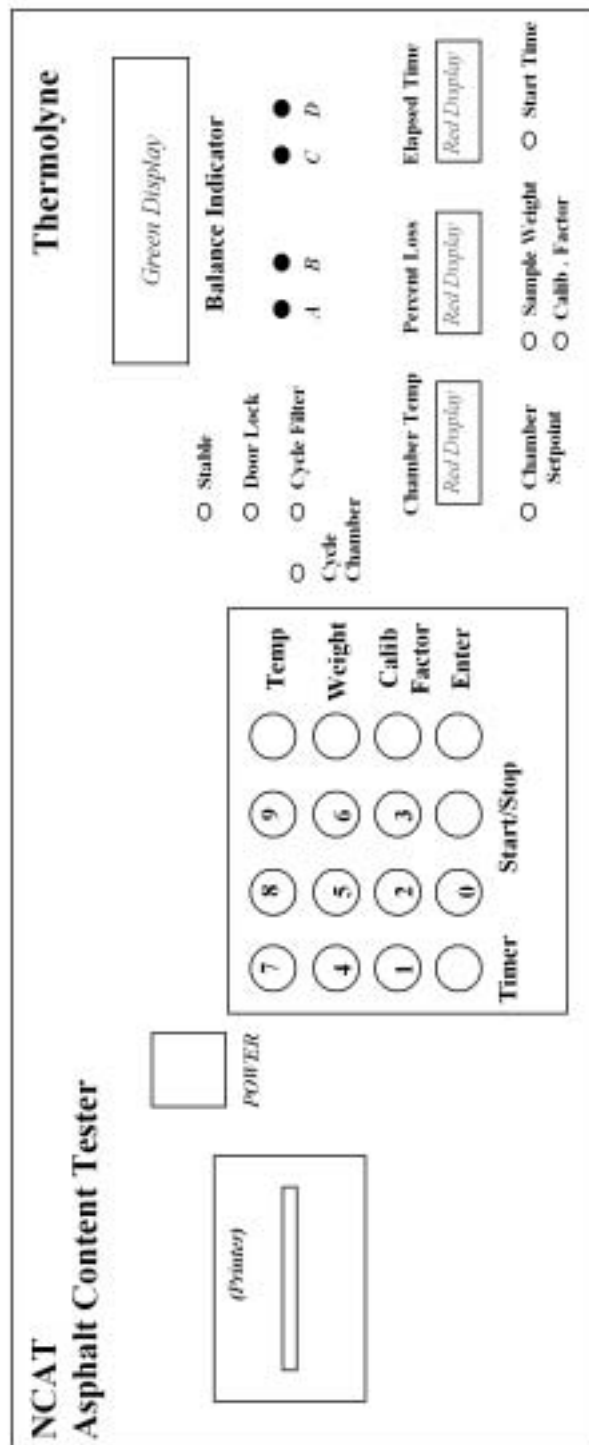

### SETRA Balance Location Ports

(When attempting to set the time/date or calibrate the SETRA balance, please refer to this drawing for balance port hole location.)

- A** = ENTER KEY
- B** = NOT USED
- C** = NOT USED
- D** = ON/OFF KEY

# Keypad Layout for 1275 Series N-Cat Asphalt Furnace

## Models: F85930, F85938, F85930-33

REPLACEMENT PART NUMBER =DL1275X4

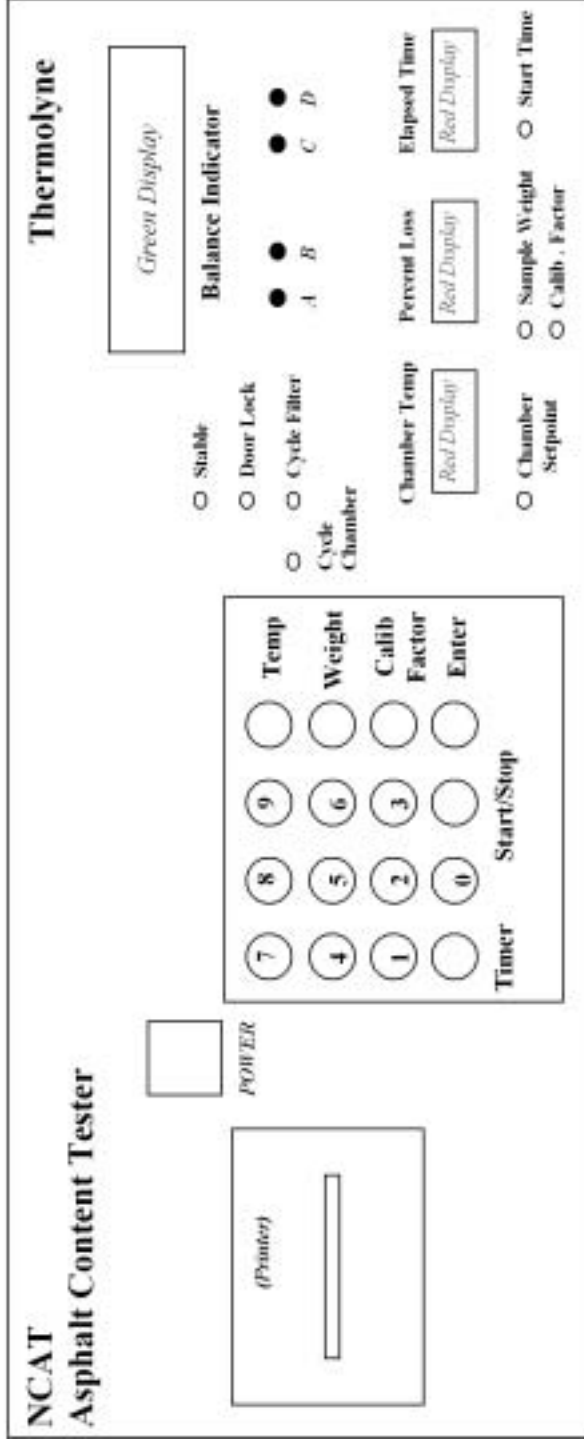

### SETRA Balance Location Ports

(When attempting to set the time/date or calibrate the SETRA balance, please refer to this drawing for balance port hole location.)

- A = ENTER KEY
- B = NOT USED
- C = NOT USED
- D = ON/OFF KEY

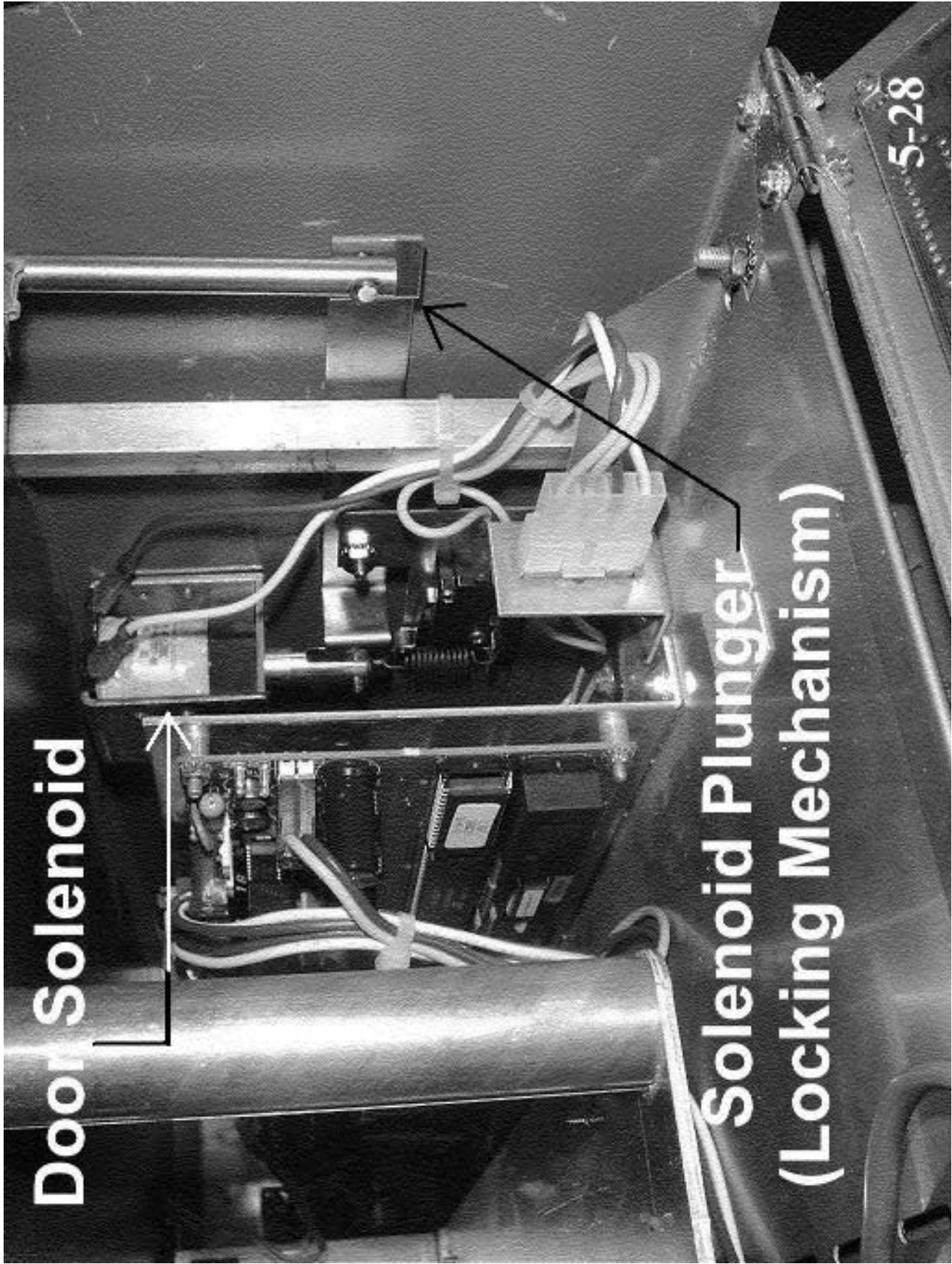

---

# Maintenance

---

## Lift Test Procedure

The efficiency of the blower and/or exhaust system is monitored by a quick test procedure, referred to as the “lift test”. Steps to perform a lift test:

1. Chamber must be at ambient (room temperature) condition before attempting to perform a lift test.
  - a) Allow the unit to cool to ambient condition.
2. Press the green power button on front display.
  - a) Allow the unit to complete the diagnostic test upon power up.
3. Press the “0” key on the keypad.
  - a) This zeros the balance.
4. Press the “start/stop” key on the keypad.
  - a) This initiates the blower motor.
5. The green display will indicate a number approximately 20 seconds after pressing the “start/stop” key.
  - a) This number is the negative lift.
6. Record the number on paper.
  - a) Ideally, the number should be between  $-3.0$  and  $-8.2$
  - b) Detach the exhaust tubing and repeat the test to determine if the exhaust system is restricting the airflow or if the top plenum of the NCAT is restricting the airflow.
7. Refer to the NCAT cleaning procedure if the lift test falls out of this range.

---

## Cleaning Procedure for NCAT

The NCAT unit must be kept clean in order to ensure proper operation. The lift test procedure is a tool to indicate when the unit needs to be cleaned. (See Lift Test Procedure) Follow the instructions below for proper cleaning. Cleaning routine should be started with NCAT at room temperature.

1. Disconnect power. Disassemble the top vent tube from the blower motor. Using a Shop-Vac, clean out the vent tube of all soot build up. Shop-Vac the chamber as well, if needed.
2. Remove the top cover of furnace and oil the blower motor with Anderoll 465 lubricant (part number AYX6).
3. Open the chamber door. Inspect the door insulation for black streaks of soot. (Usually running from the outside corners of the insulation towards the center.) If black streaks are present, it is a sign the door is loose and the chamber is sucking in air. (If there is no black streaks then continue to step 4.) Tighten the door by opening it at a 90-degree angle in reference to the front of the chamber. Loosen the door hinge screws and push the edge of the door into the front left edge of the chamber. Tighten down the hinge screws while the door is being pushed in, towards the front left edge of the chamber/hinges. Replacing the door insulation maybe necessary (part number JC412X10, quantity to order = 4).
4. In the 1087 and 1275 series NCATs there is a hole in the back of the chamber. This hole is the opening that extends upward into the top plenum. It acts like a chimney to prevent smoke buildup in the chamber. Ensure this chimney is free of any soot buildup. A pipe cleaner or stiff wire can be used to clean out the chimney. NOTE: This piece of insulation may need to be replaced if lift tests remain out of spec after this entire cleaning procedure is executed. (See troubleshooting section for more details.)

5. Reconnect power. Increase the chamber set point temperature to 650°C using the chamber set button. Increase the filter set point temperature to 900°C by performing a hidden key 5 to change filter set point temperature as follows: Turn the green power switch “off”. Press and hold the #5 key in while pressing the green power switch. Once the furnace “beeps”release the #5 key.)
6. Allow the unit to reach and maintain the 650°C/900°C condition for at least 3 hours. (The furnace has a course filter in the top plenum that will burn itself clean.) Do not initiate a cycle, let the unit in the idle mode for the duration.
7. After this 3-hour period, reset the chamber temperature to your desired burning level. Reset the filter temperature to 750°C by performing the hidden key #5 routine.

Routine cleaning of the NCAT is complete.

---

## Chamber Temperature Verification/Calibration

NCAT Specifications:

Chamber Size = 14" x 14" x 14"

Chamber max set point = 650°C

Filter max set point = 900°C

Factory default set point temperatures = 538°C chamber; 750°C filter

NOTE: The 859 or 945 Series NCATS do not have a predrilled calibration port. Customer may need to remove back cover and drill their own 1/4" diameter port through the back wall. View page 115 for a view of the back of the unit and the location of the port.

NOTE: 1087 & 1275 series NCATS have a predrilled calibration port-hole with an access cover on the back of the furnace. You do not need to remove the back cover to access the port-hole.

NOTE: It is not possible to calibrate or verify the filter temperature of NCAT furnaces.

NOTE: To verify or calibrate chamber temperature, you will need an N.I.S.T. traceable digital pyrometer (Barnstead International part number = PM20700) & an N.I.S.T. 10" Type K thermocouple probe (Barnstead International part number TC405X2). These can be calibrated to N.I.S.T. standards and shipped with a certification of calibration (Barnstead International part number = C5000) dated for 1 year. Calibration of the two test pieces of equipment will need to be performed every year. Contact Barnstead International for more details at 800-553-0039

NOTE: Chamber temperature calibration should only be performed in the IDLE mode. Attempting calibration in the TEST mode will produce inaccurate results primarily because the exhaust fan is activated in the TEST mode, pulling ambient air (approximately 10CFM) through the chamber.

---

## Chamber Temperature Calibration Procedure

PLEASE READ ENTIRE CALIBRATION PROCEDURE BEFORE PROCEEDING.

1. Power the NCAT on while holding the #5 key in (Hidden Key #5 routine). When the unit beeps, you may release the #5 key. The Hidden Key #5 routine will allow you change the filter set point temperature. Key in 500°C for the filter set point.
2. Cycle the power to the NCAT unit off and back on to exit the hidden key #5 routine and return to idle mode.
3. Set the chamber temperature to 500°C.
4. Allow the unit to heat to the chamber/filter set point (approximately 2 hours) and stabilize for an additional 2 hours before proceeding.
5. Insert 10" Type K probe (B/I part number TC405X4) through the temperature calibration port on the back of the unit.

---

## MAINTENANCE

6. Connect the probe to the digital pyrometer (B/I part number = PM20700) & power up the pyrometer.
7. Record the chamber temperature reading as indicated by the pyrometer.
8. Power off the NCAT.
9. Power the NCAT back up while holding the #3 key in (Hidden Key #3 routine). When the unit beeps, you may release the #3 key. The displays will read "CHBR CAL" in the percent loss and elapsed time windows. The Hidden Key #3 routine will allow you to key in the chamber temperature as measured by the pyrometer and recorded in step 7.
10. Enter the new chamber temperature value (recorded in step 7) followed by pressing the enter key. The new offset value will be calculated and the entered temperature value will be displayed. (The entered temperature is a temporary set point. The original set point will return upon exiting the hidden key #3 routine by powering the unit off and back on.)
11. Power off the NCAT. (Green power switch)
12. Temperature calibration is now complete.

- Chamber temperature should be +/- 10°C difference between unit temperature and probe temperature at 500°C.

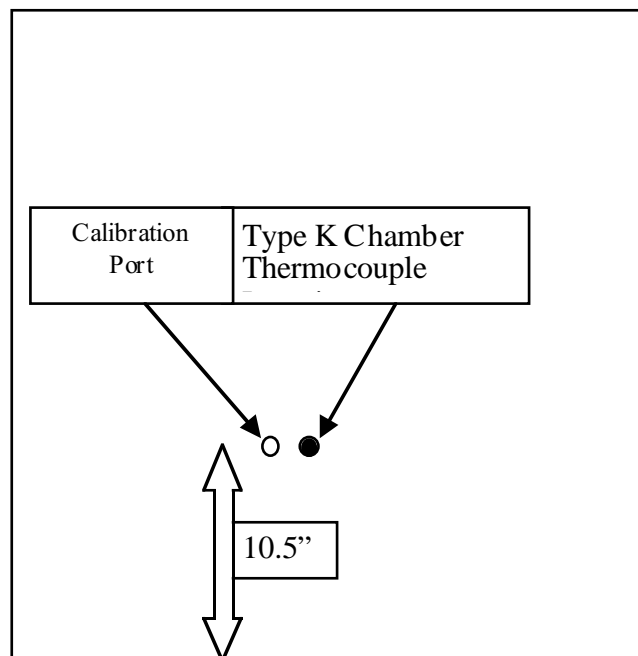

*Back view of chamber section (859 & 945 series) with cover removed. A 1/4" diameter hole is predrilled through the stainless steel sheet metal but is not predrilled through the chamber insulation material. A 1/4" diameter hole must be drilled through the insulation material to access the chamber.*

## Balance Calibration

Please refer to the "Balance" section of this manual for complete calibration procedures.





# DRAWINGS

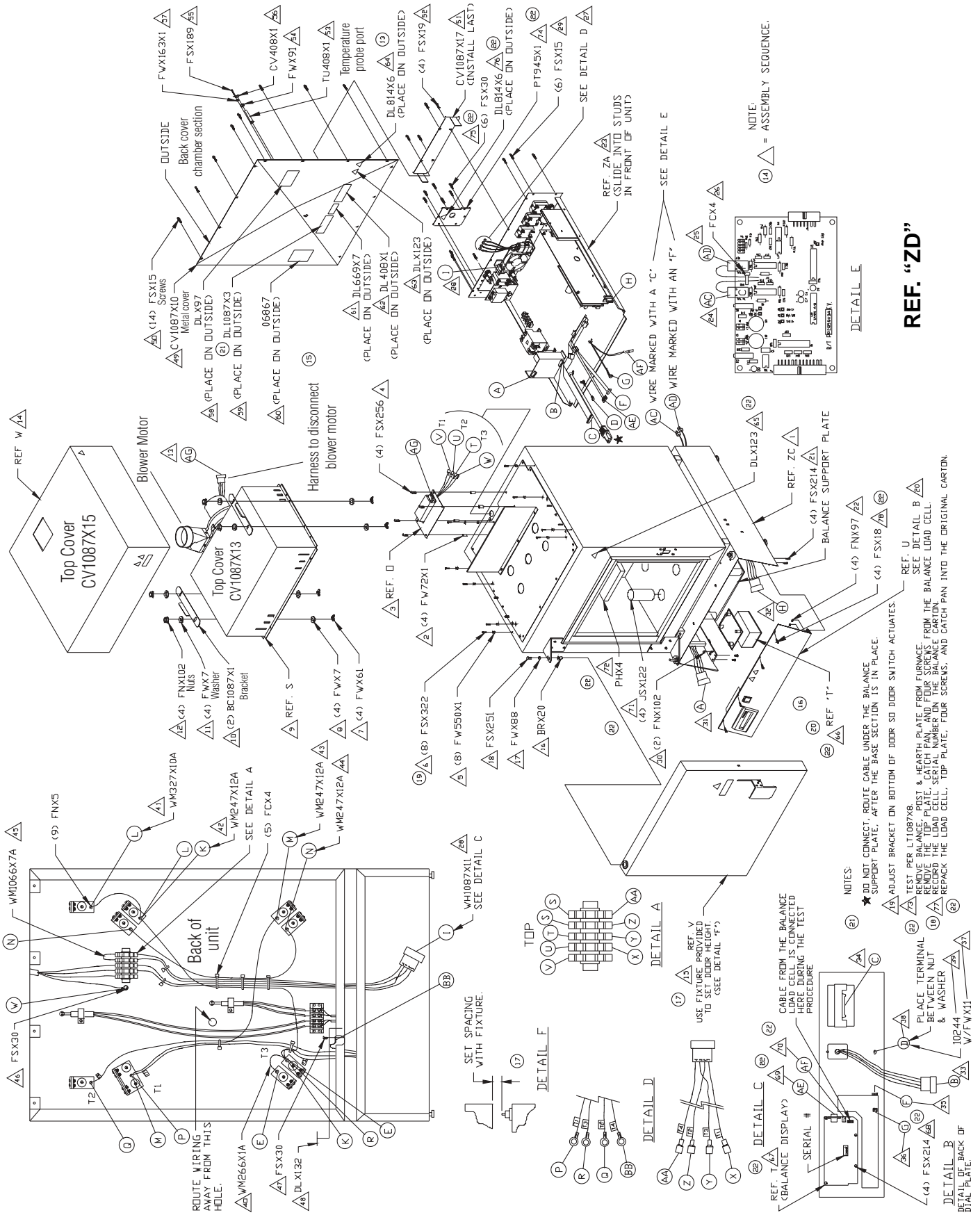

REF. "ZD"